

Teaching and Research Equipment for

Solar Energy

- Photovoltaics and solar thermal energy
- Understanding the basics
- Using practical knowledge

The 2E programme range: introducing your solar energy experimental units

GUNT Gerätebau is known around the world as a competent provider of technical training equipment with 35 years of experience. The 2E programme range from GUNT brings together topics from the fields of energy and environment, particularly in terms of sustainability. With its redesigned focus on solar energy, GUNT is confronting the global challenges of today.

Entering the solar age

The amount of solar energy that falls on the Earth's land areas in a year is almost 2,000 times greater than the entire world's energy demand. Given the global climate problem, usage of this potential in the best possible way is self-evident.

In order to illustrate the importance of solar energy for the future energy supply, the illustration shows a comparison of some fossil energy reserves.

Putting solar energy to good use

In principle, two different areas can be distinguished in solar energy usage: photovoltaics and solar thermal energy.

In photovoltaics, electrical energy is created directly, whereas in solar thermal energy first heat is generated which is either used directly or converted to electrical energy in large-scale solar power plants by means of heat engines.

Both types of usage compete with each other in the range of a few megawatts of electric power. It is possible to build large photovoltaic installations consisting of several thousand solar modules. However, it is equally conceivable to provide the same power with a thermal parabolic trough power plant. Which technology is chosen is largely dependent on the planned site and its integration into the supply grid.

The advantage of smaller solar installations is the ability to provide electricity and/or heat close to the consumer and according to demand. In order to tap the full potential of solar energy as a sustainable energy supply, it is essential that we understand and develop modern concepts of use.

In this context, we consider our mission to be to develop equipment for engineering education in the field of solar energy.

Our teaching units help you and your students to gain experience with applications, to deepen your understanding of basic principles and to examine specific issues of efficient systems.

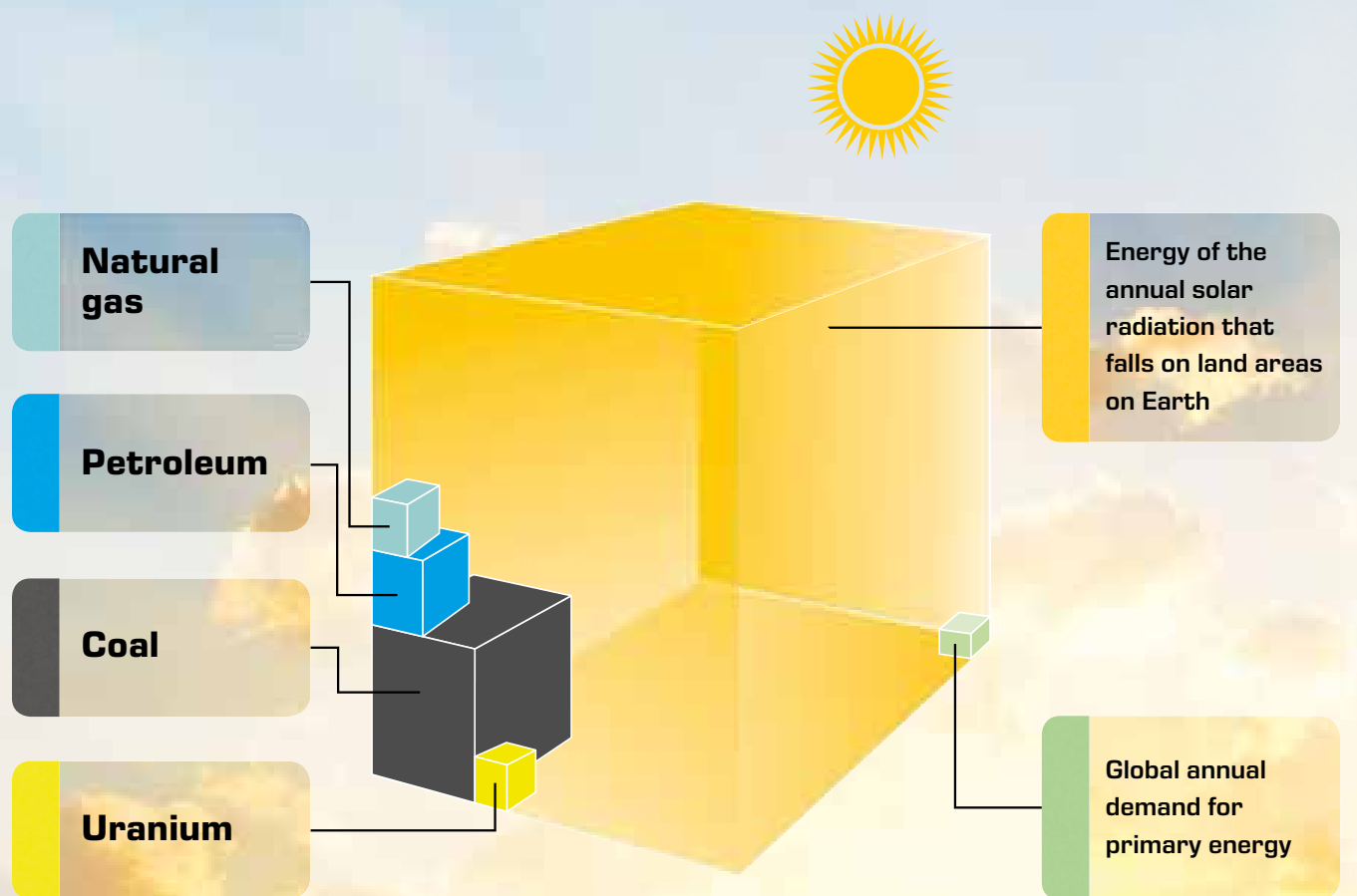

Photovoltaics

In recent years, successful development of technology and economic incentives have led to a significant growth in installed photovoltaic capacity.

Generated solar power is fed directly into an energy provider's grid or consumed on site.

The advantages of this type of power generation are well known: solar power contributes to protecting the environment, reduces the cost of electricity transmission and provides an independent and affordable energy supply.



Growth of installed photovoltaic capacity in Germany in GW_{pv} (source: BSW-Solar)

Solar thermal energy

The energy from solar thermal collectors has up until now mostly been used for heating and domestic water heating. In addition however, solar thermal energy can also be used as a source for process heat in industry, for steam generation in power plants and can even be used for cooling. Different types of collectors are used, depending on the application.

The chart below shows the installed collector area as a measure of the annual growth in solar thermal installations.

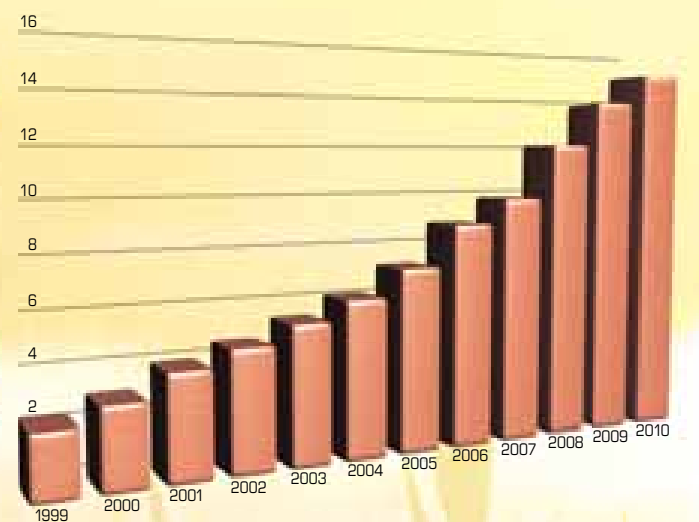

Growth of solar thermal collector area in Germany in million m² (source: BSW-Solar)



Visit our website at www.gunt2e.de

2E by GUNT: demonstrating the potential of solar energy in engineering education

Teach the different methods of using solar energy as part of a structured curriculum.

The didactic concept

Meaningful steps on the key elements of photovoltaics

Application technology 1
Correctly installing photovoltaic solar modules

Fundamentals of photovoltaics
Technological fundamentals of cells and modules

Application technology 2
Investigation and simulation of systems

2E teaching units for photovoltaics



ET 250 Solar Module Measurements

Function of solar modules

Page 4

Page 6
ET 250.01

Page 7
ET 250.02



ET 252 Solar Cell Measurements

Trainer with four solar cells and bypass diodes that can be freely interconnected

Page 9



ET 255 Using Photovoltaics: Grid-connected or Stand-alone

Trainer with photovoltaic simulator for work with electrical components from the practical field of photovoltaic systems

Page 10

Learn the fundamentals and applications of solar heat generation

Application technology 1
Use of modern flat collectors

Fundamentals of solar thermal
Parameters affecting solar thermal heat generation

Application technology 2
Combined use of renewable heat

2E teaching units for solar thermal energy



HL 313 Domestic Water Heating with Flat Collector

Use of solar thermal energy with real-world components

Page 13



ET 202 Principles of Solar Thermal Energy

Model of a solar thermal system

WL 377 Natural Convection and Radiation Apparatus

Heat transfer by convection and radiation in gases

Page 15



HL 320 Solar Thermal Energy and Heat Pump Modular System

Combination of different modules, freely configurable universal controller

Page 17

Correctly installing photovoltaic modules

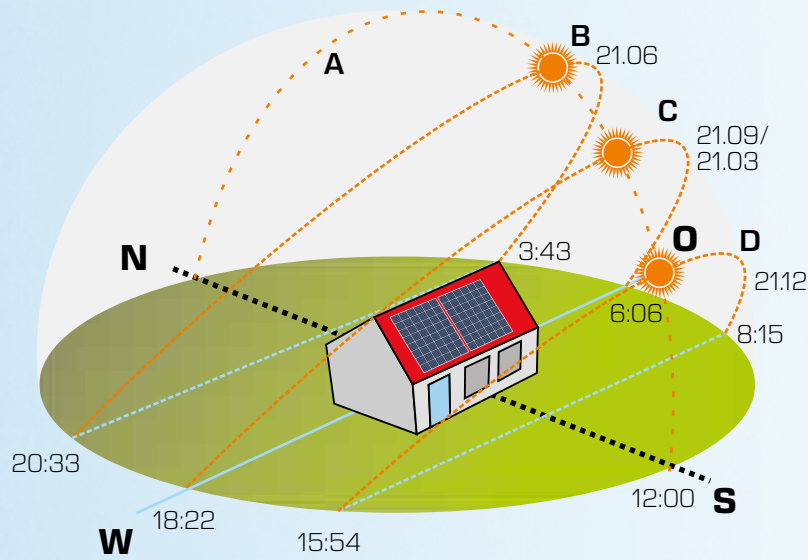

The orientation of the module surfaces to the cardinal point and their inclination play a significant role in optimising the yield of a solar system.

The figure shows the path of the sun visible on the Earth at different seasons of the year. The times given for sunrise and sunset are for Berlin:

- A Zenith
- B Summer solstice
- C Beginning of spring/autumn
- D Winter solstice

From cell to module

The solar cell is the smallest unit of a photovoltaic module. A single cell only produces a low open-circuit voltage of about 0.6 volts. This voltage is not sufficient to feed electrical energy into the grid or to operate consumers. A module therefore combines several interconnected cells in one unit. Common modules achieve open-circuit voltages of about 12 or 24 volts. At these voltages it is entirely possible to operate a DC load or to charge a battery. The module thus represents the smallest form of a photovoltaic generator. A complete photovoltaic system contains additional components to convert and provide the solar power for further usage.

Optimizing the operating point

The electrical capacity of the photovoltaic module is given by the product of current and voltage at the operating point. Here, the operating point is determined by the electrical load of the connected consumer.

The complete current-voltage curve must be known in order to check whether the optimum operating point has been reached. The characteristic can be measured with a variable load resistor.

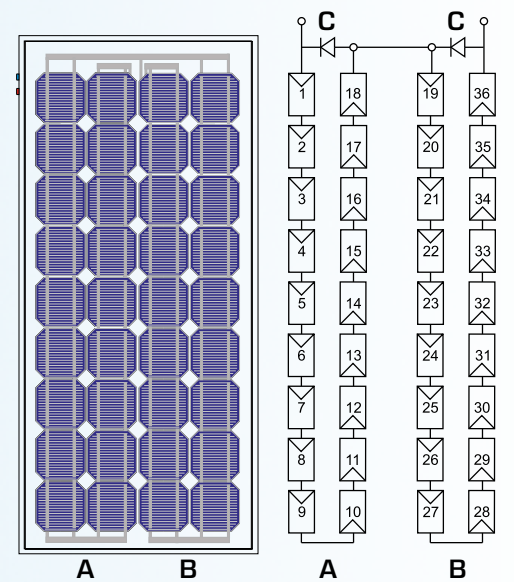

In typical photovoltaic modules, 18 cells are connected in series in strings. Each string (A, B) is protected by a **bypass diode** (C). In this case a part of the module capacity is retained if one string fails and individual cells are protected from damage.

Module encapsulation

Standard cells are made of thin silicon wafers. They have to be integrated in the module after the electrical bonding and must be protected against any weather conditions.

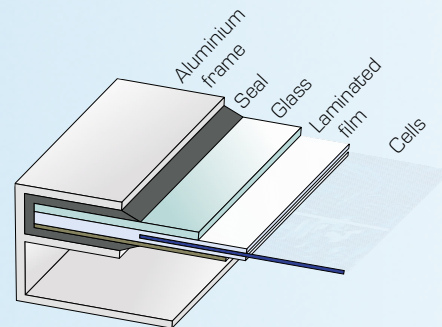

ET 250 Solar Module Measurements

Operating principle

With this trainer, you can practically demonstrate all key aspects in the operation of solar modules.

ET 250 has two solar modules, which can be connected either in series or in parallel. You can adjust the tilt angle of the modules individually. A display unit is provided for the experiments, which clearly displays all relevant measured values.

Current-voltage curves can be created from the measured values. These characteristics are an important criterion for assessing the capacity of a photovoltaic system.



Familiarisation with practical solar power generation in photovoltaic modules with **ET 250**

Learning objectives

- Physical behaviour of photovoltaic modules under varying illuminance, temperature and shading
- Familiarisation with key characteristic variables such as short-circuit current, open-circuit voltage and maximum capacity
- Recording current-voltage curves in parallel and series connection
- Influence of the inclination of the solar module
- Calculation of the efficiency



The device components

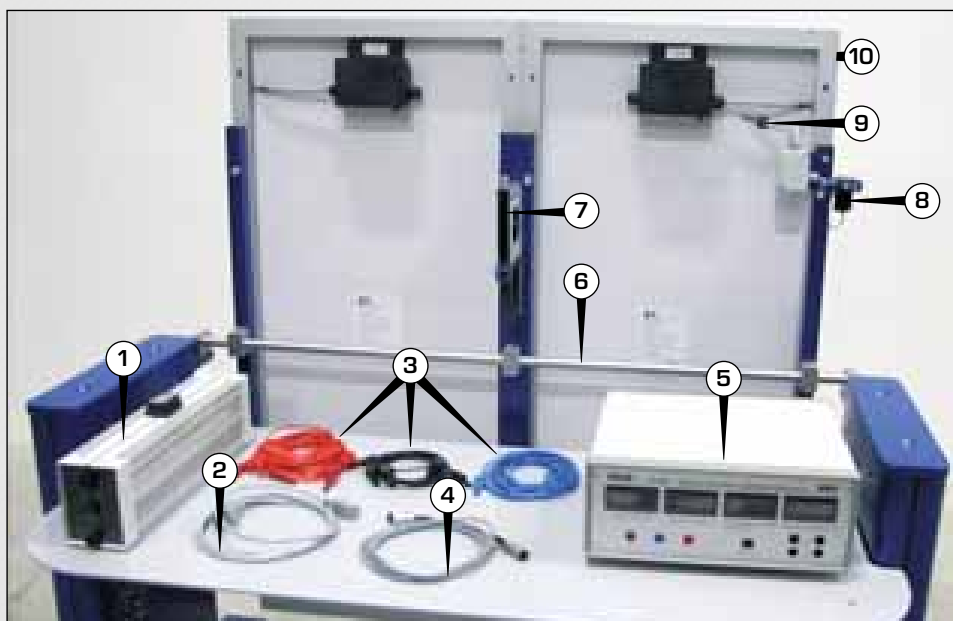

1 slide resistor, 2 power cord, 3 set of cables for parallel and series connection, 4 measuring cable, 5 measuring unit, 6 tilt axis, 7 inclinometer, 8 illuminance sensor, 9 temperature sensor, 10 photovoltaic modules



Illuminance sensor

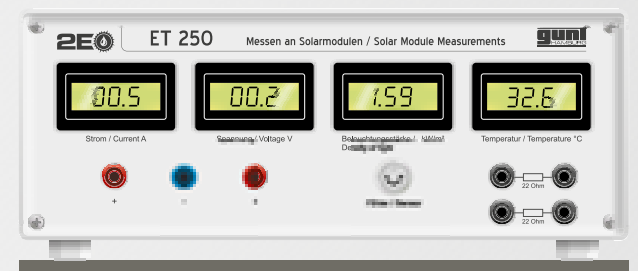

The measuring unit



Bypass diodes on the module

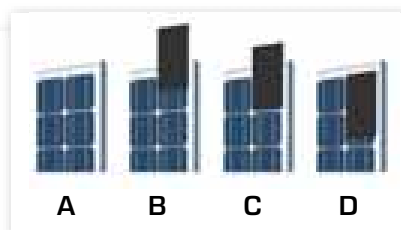
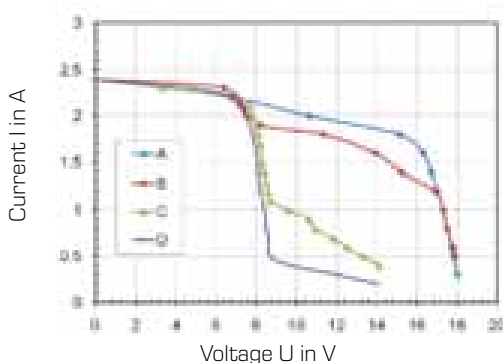

Experiments in shading

In many places, shading is a major cause of yield losses. ET 250 is also designed for specific experiments on this effect. The results can be compared with documented reference experiments. The figure shows current-voltage curves for different shading levels of individual cells of a module.



See here for more details and technical data.

The accompanying instructional material

The well-structured instructional material sets out the fundamentals and provides a step-by-step guide through the experiments. Topics include the consideration of meteorological data as well as system design.



Feeding solar electricity into the grid



Initially photovoltaic applications were restricted to niche markets such as the supply of hard-to-reach consumers. Nowadays however, the vast majority is installed in grid-connected operation. In grid-connected operation the generated solar power is fed into a public power grid after having being converted into alternating current. The main components of a grid-connected system are shown in the following figure:

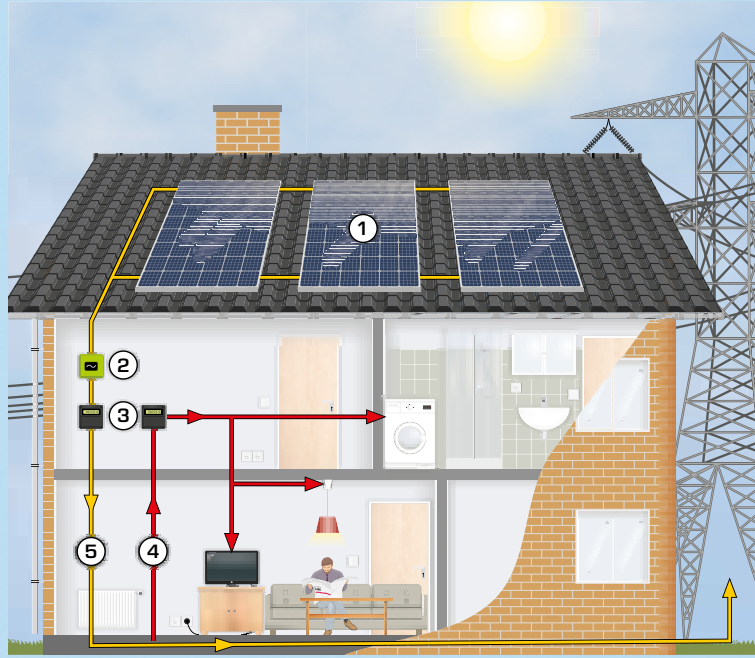

- 1 photovoltaic modules
- 2 inverter
- 3 electric meter
- 4 connection to consumers
- 5 grid feed-in

The supplied solar power is measured by a feed-in meter approved by the grid operator. The electricity demand for the domestic supply is so far mainly covered from the public grid and measured by a second electric meter. In order to specifically encourage the domestic consumption of generated solar power, this sort of usage is charged separately in Germany.



System safety

The increasing number of grid-connected photovoltaic systems has resulted in particular demands for technology to stabilise mains voltage and frequency. Furthermore, safety devices such as for lightning strikes or fire fighting are required in order for a grid-connected photovoltaic system to be approved.

ET 250.01 Photovoltaics in Grid-connected Operation

Components and function

ET 250.01 is designed as an extension module for ET 250 and allows you to expand the learning objectives of ET 250 consequently.

ET 250.01 contains practical components from the field of photovoltaics which are needed to use the solar power when connected to the public grid. These include:

- DC circuit breaker (A)
- Overvoltage protection (B)
- Grid-commutated inverter with MPP tracker and grid monitoring (C)
- Bi-directional feed-in meter with smart-metering functions (D)
- Meter for own consumption (F)
- Socket (G)

The components are arranged clearly in a wiring diagram. Test terminals are included at relevant points of the circuit to allow the use of hand-held instruments for measuring current and voltage. Feed-in energy and domestic consumption are recorded via energy meters.

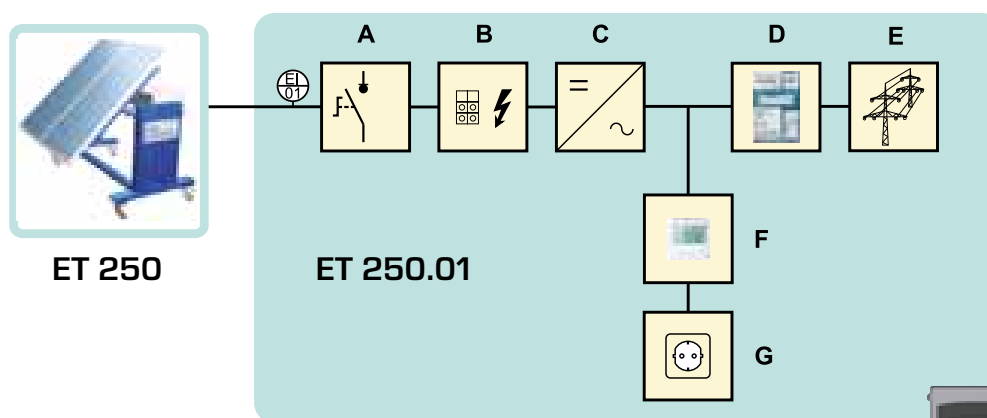

Learning objectives

- Function of components for grid-connected operation
- Safety devices in photovoltaic systems
- Function of a grid-commutated inverter with maximum power point tracker (MPPT)
- Function of modern bi-directional energy meters for grid feed-in
- Conversion efficiency of a grid-commutated inverter
- Energy balance in grid-connected operation

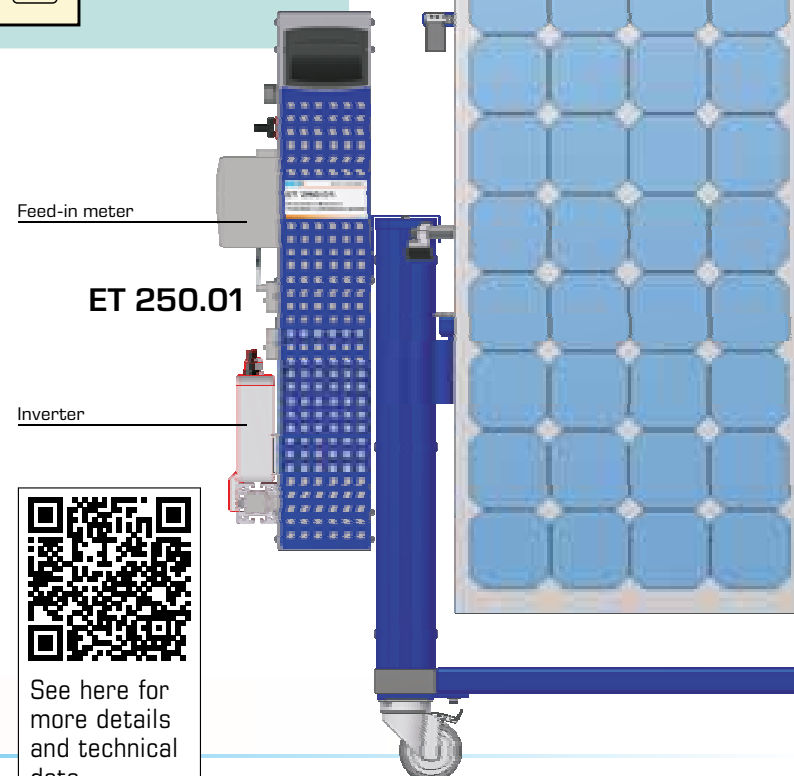

See here for more details and technical data.



Powering remote health clinics

The electrical energy ensures that medications are kept cool during the day. Excess energy is stored in batteries and is made available at night to light the treatment rooms.



Lighting navigation buoys

Illuminated navigation buoys have long been used at particular sites to mark navigation channels. If the energy required for the light source is provided by a photovoltaic stand-alone system, other energy sources are not needed. This considerably reduces the operating costs, especially in inaccessible areas.

Solar power for off-grid supply

Photovoltaic systems are used in stand-alone operation when no mains grid can be connected to, for example in remote locations. A typical stand-alone system includes the following components:

- Photovoltaic generator
- Voltage converter
- Charge controller
- Batteries
- Consumer

Important aspects of typical stand-alone systems can be investigated even in small systems. The dimensioning of modules and storage size is crucial for a reliable supply. Variations in the solar energy supply due to the time of day or season of the year, as well as the expected peak load of the application have to be taken into consideration.

ET 250.02 Photovoltaics in Stand-alone Operation

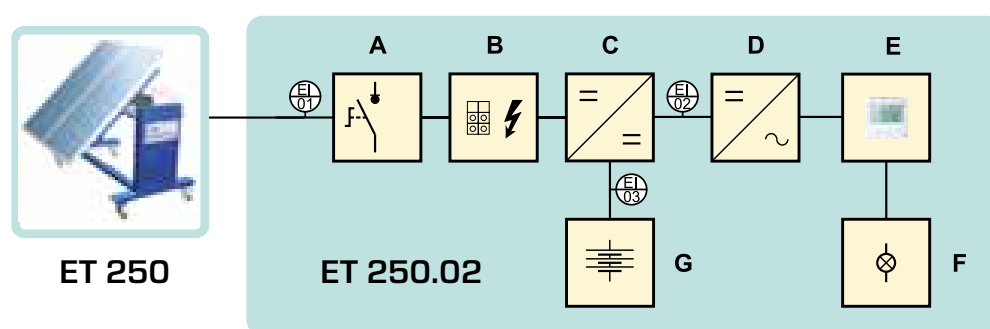

Components and function

ET 250.02 is another extension module for ET 250. The unit allows you to teach key aspects of solar energy use in stand-alone systems. ET 250.02 contains all the necessary components:

- DC circuit breaker (A)
- Overvoltage protection (B)
- Charge controller with MPP tracker (C)
- Stand-alone inverter (D)
- Meter for own consumption (E)
- Halogen lamp as electrical load (F)
- Battery (G)

Learning objectives

- Function of components for stand-alone operation
- Function of a charge controller
- Use of batteries
- Inverters in stand-alone operation
- Safety devices
- Conversion efficiency of a stand-alone inverter
- Energy balance in stand-alone operation

In order to conduct the experiments, the photovoltaic modules from ET 250 are connected to ET 250.02. The charge controller starts working as soon as it is supplied with solar power. It is now possible to investigate the MPP tracking and behaviour at various battery charge states. Test terminals integrated in the wiring diagram allow measurements of current and voltage using hand-held instruments.

The energy meters can be used to measure the consumption of a lamp that is part of the experiment module.

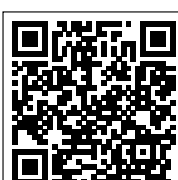
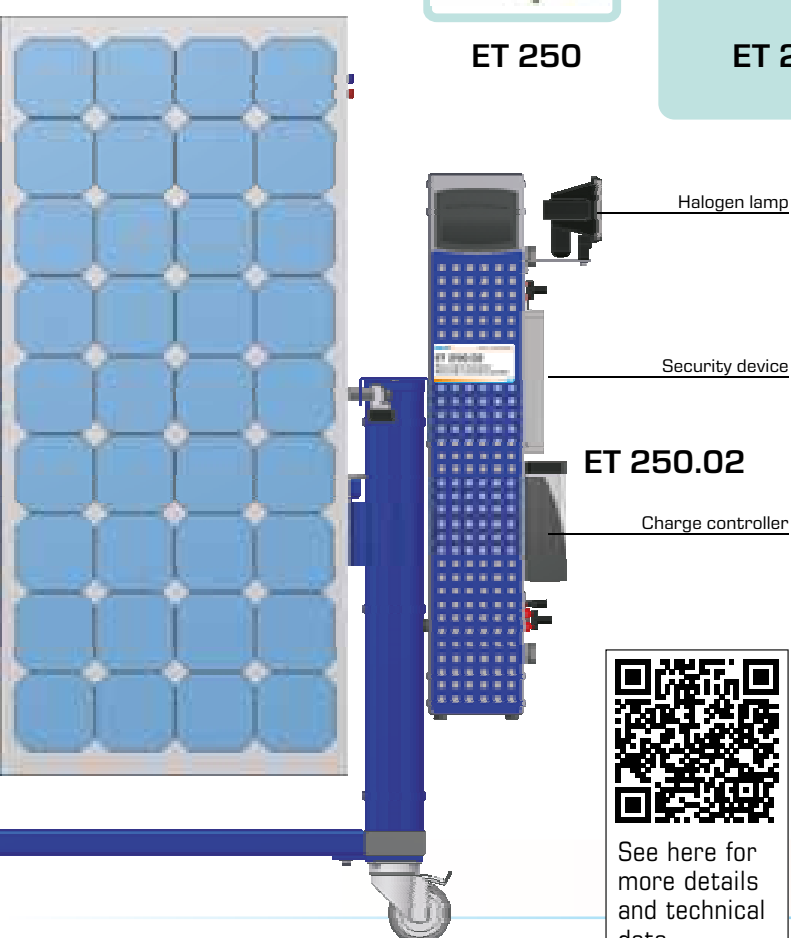

See here for more details and technical data.



Develop the fundamentals of photovoltaic solar cells under defined conditions

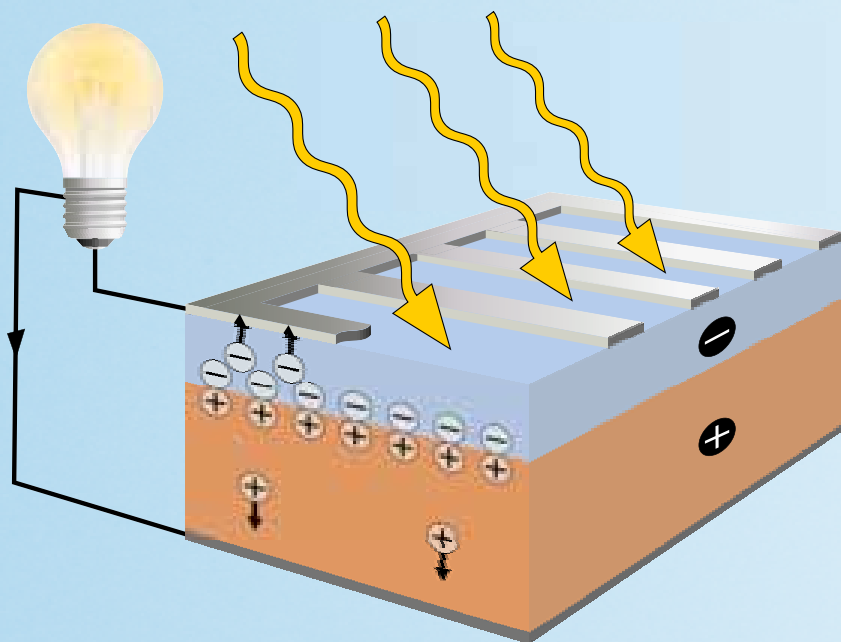

How a solar cell works

A typical solar cell consists of two different layers of semiconducting silicon. Doping with phosphorus or boron creates a surplus of electrons in the upper layer and a deficiency of electrons in the lower layer.

The doping results in an electric field within the solar cell. The upper layer acts as a negative pole (cathode) and the lower layer acts as a positive pole (anode).

The absorption of light (photons) mobilises the electrons in the solar cell. The excited electron can move in the conduction band, leaving a positively charged mobile hole in the valence band.

Production

After Alexandre Edmond Becquerel discovered the photoelectric effect in 1839, it was another 100 years until the first silicon solar cell was produced in 1954. The most widely used are monocrystalline or polycrystalline silicon solar cells. At the beginning of the production very thin silicon discs (wafers) are cut from a silicon block as the starting material.

A number of other steps are required before the finished cell is ready. They mainly fall into the following processing stages:

- Doping (installation of the electric field)
- Passivation (reduction of material errors)
- Bonding (screen printing with conductive pastes)

The yield of a solar cell depends on the temperature

Up to 25% of the solar energy is converted into electrical power during operation. The remaining portion causes the solar cell to heat up. Resulting effects in the semiconductor material cause a reduction in the efficiency of the solar cell. Therefore it is a good idea to mount the modules at a sufficient distance from the base, in order to ensure cooling by air flow on the back of the module.

The **ET252** trainer allows you to investigate the effect of temperature on the solar cell.

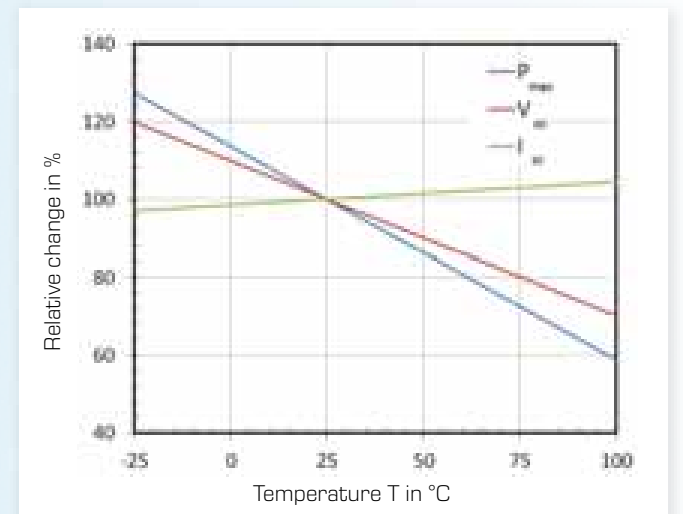

Relative temperature dependency of power (P_{max}), open-circuit voltage (V_{oc}) and short-circuit current (I_{sc})

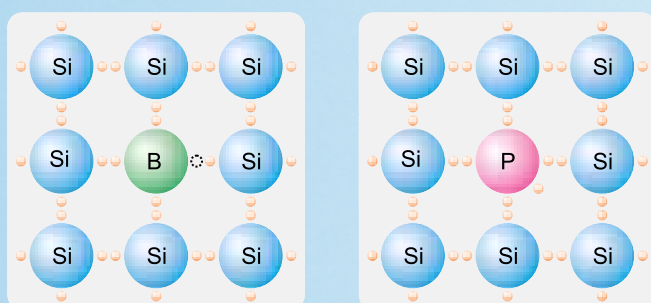

Doping of silicon: phosphorus leads to a surplus of electrons; boron produces a deficiency of electrons



Production line for the manufacture of silicon solar cells

ET 252 from solar cell to module



Software with tutorial function

The extensive software can be used to operate all device functions via USB from an external PC or laptop. Besides controlling the brightness and temperature, it is also possible to configure the automated measurement of the characteristic curve via the **software-controlled current sink**.



Learning objectives / experiments

- Current-voltage curves of solar cells
- Series and parallel connection of solar cells
- Effect of temperature on the solar cell parameters
- Behaviour of the solar cell at different illuminance and partial shading

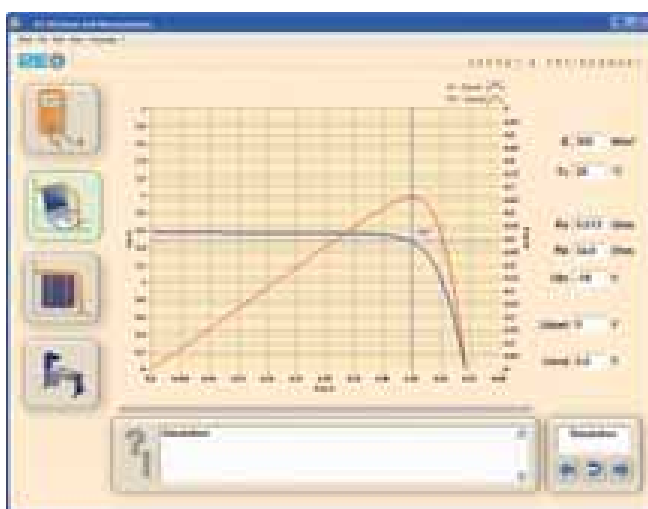

The software also includes an integrated **tutorial function** that aids the introduction to the fundamentals of photovoltaics in didactically balanced steps and that supports the device's various measurement capabilities.

Animations illustrate the fundamentals of interconnected cells and the selectable options on the integrated patch panel.

Functions of the trainer

ET 252 allows you to demonstrate the fundamentals of photovoltaics in carefully thought out experiments. Four solar cells are the main components of the experimental unit. These cells are irradiated with an adjustable lighting unit. A regulated Peltier cooling element selectively controls the temperature of the solar cells. This allows comparative measurements on the influence of temperature on the characteristic variables of the cells.

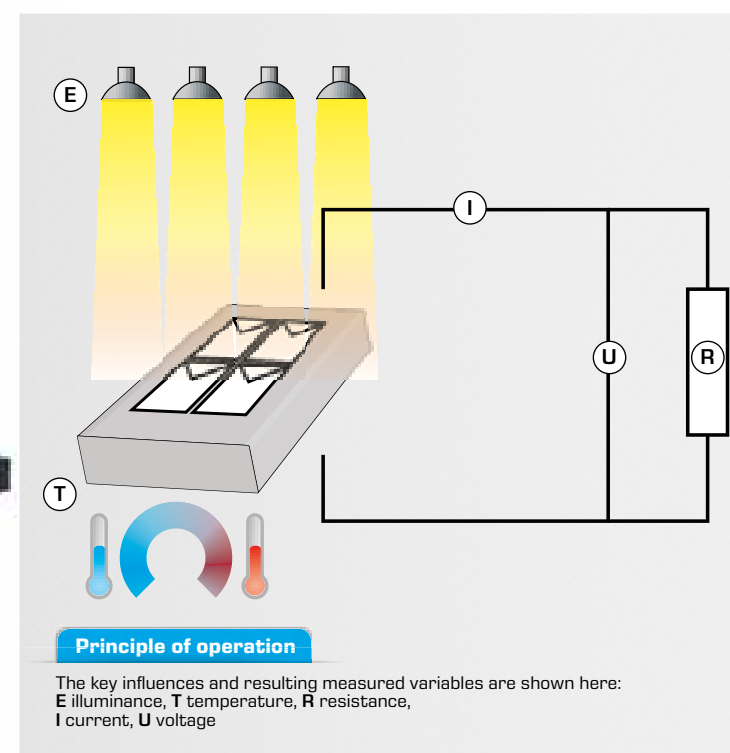

Two issues are central to the didactic concept:

Circuit types

In a series circuit, the voltages of the separate solar cells are added together. The current remains constant. On the other hand, in a parallel circuit the voltage remains constant, while the currents of the individual cells are added together.

Current-voltage curves

Current-voltage curves are used to assess the capacity of a photovoltaic system. The characteristic curve depends, among other things, on the illuminance and the temperature.



See here for more details and technical data.

2E a division of

gunt
HAMBURG

Using solar power effectively

Simulating operating conditions

In both stand-alone and grid-connected systems, changes of illuminance, temperature and utilisation result in a shift of the electrical operating point. This results in changes to the operating conditions for system components and variances in efficiencies.

This behaviour of the system components can be investigated by field experiments with photovoltaic modules or by simulating their current-voltage curves.

The data obtained in this way can be used to predict system yields based on meteorological data. For inverters, the behaviour in the partial load range in particular must be taken into account. For example, in the case of utilisation of a fifth of the rated power, the efficiency can fall below 60%.

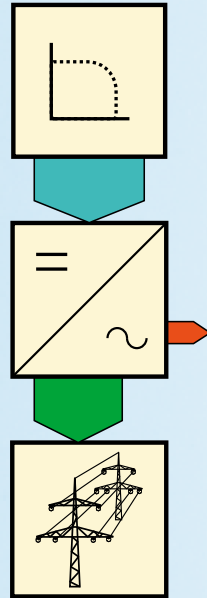

The energy use factor

The energy use factor of an inverter can be calculated, for example over a period of one year. It is derived from the ratio of the actual amount of energy used to the theoretically available energy supply of the connected photovoltaic modules. To achieve a high energy use factor, the inverter should be optimally matched to the capacity of the connected modules and the year-round distribution of the solar energy supply.

Capacity optimisation in grid-connected and stand-alone operation

The maximum power point of a photovoltaic module shifts with changes in illuminance and temperature. In grid-connected operation, the necessary adjustment of the maximum power point (MPP tracking) is usually achieved by an integrated function of the inverter. For systems in stand-alone operation, this function is often included in the functionality of the charge controller.



ET 255 Using Photovoltaics

Grid-connected or Stand-alone

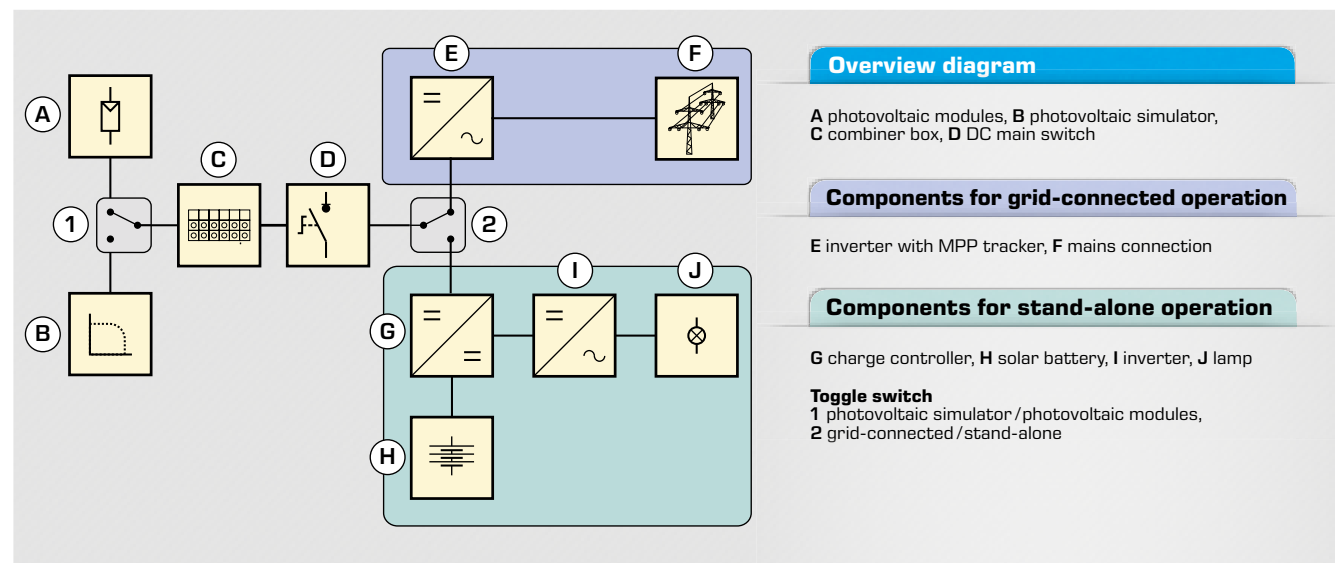

Operating principle

The ET 255 trainer allows you to investigate real world components from the photovoltaic field for mains feed-in and for stand-alone operation under real operating conditions. You can work with real photovoltaic modules (ET 250) or use the integrated photovoltaic simulator.

The photovoltaic simulator is controlled and configured by software. Other software features enable the measurement and display of measured values and thus support the achievement of each specified learning objective.

A module inverter is available for grid-connected operation. In stand-alone operation, different charge controllers, an inverter and a battery can be used.

ET 255 is fitted with measuring points for current and voltage to allow electrical measurements with hand-held instruments at all relevant points.

Learning objectives / experiments

- Function of grid-commutated inverters
- Function of charge controllers and batteries in stand-alone operation
- Efficiency and dynamic behaviour of system components
- Function of MPP tracker

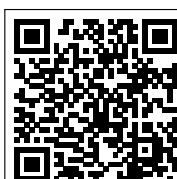

See here for more details and technical data.

ET 255 the software

Operation and data acquisition

Operating status and current measuring values are displayed clearly with the ET 255 software. The measuring values can be continuously saved for later analysis in external spreadsheet programs.

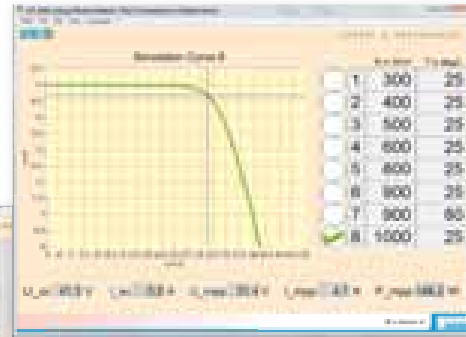
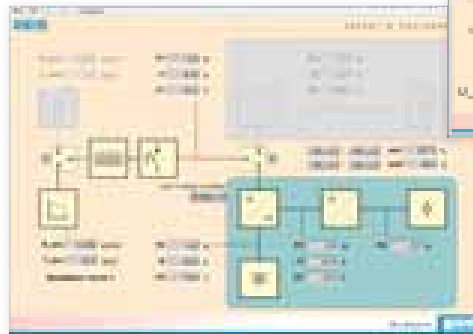

The photovoltaic simulator

The photovoltaic simulator's easy to understand user interface can be used to select curves for different illuminances and temperatures. The two-diode model forms the theoretical basis for calculating the current-voltage curves.



Basic concepts from the practical field of modern photovoltaic use can be taught with ET 255 in systematic steps.

Combine ET 255 with ET 250 and HL 313.01

The 2E devices from the field of photovoltaics are part of a modular concept. The extended device combination for photovoltaics consists of the following devices:

- ET 250 Solar Module Measurements
- HL 313.01 Artificial Light Source
- ET 255 Using Photovoltaics

When connecting ET 250 to ET 255, the measured values from the photovoltaic modules are transmitted to ET 255.

The data can be recorded and displayed with the corresponding software. As shown below, these data can be used in spreadsheets for yield calculations.

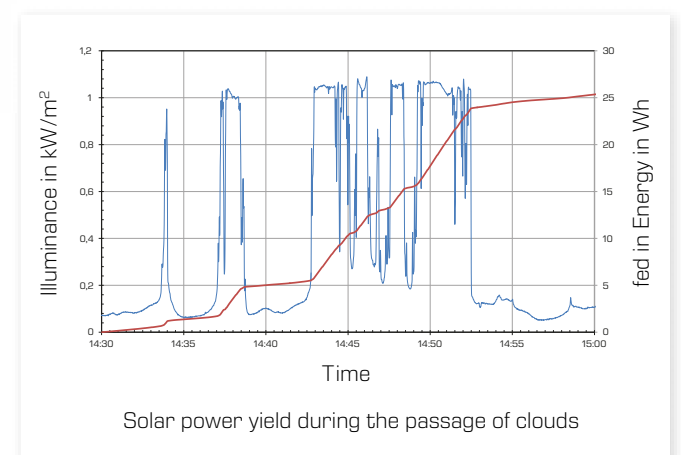

ET 255 in use at the FH Joanneum University of Applied Sciences, Austria

At FH Joanneum in Kapfenberg, Austria, the ET 255 trainer is used for practical experiments in the field of energy and environmental management. The PV simulator can be used to conduct experiments on the efficiency of PV systems without interference from the weather.



Instructional materials

An instruction manual specifically adapted to the range of experiments provides an introduction to more complex systems. For example, the main part provides important background information for the appropriate operation of the battery.

Understanding solar thermal energy step by step

Real-world use of thermal solar energy

The main fields of application for solar thermal energy are the heating of domestic water and to aid central heating. Different collector types are suitable depending on the application and required temperature.

For example, since comparatively low temperatures are required to heat swimming pools, often only simple collector types are used for this purpose.

On the other hand, if very high temperatures are required, more efficient collector types like the vacuum tube collector are appropriate.

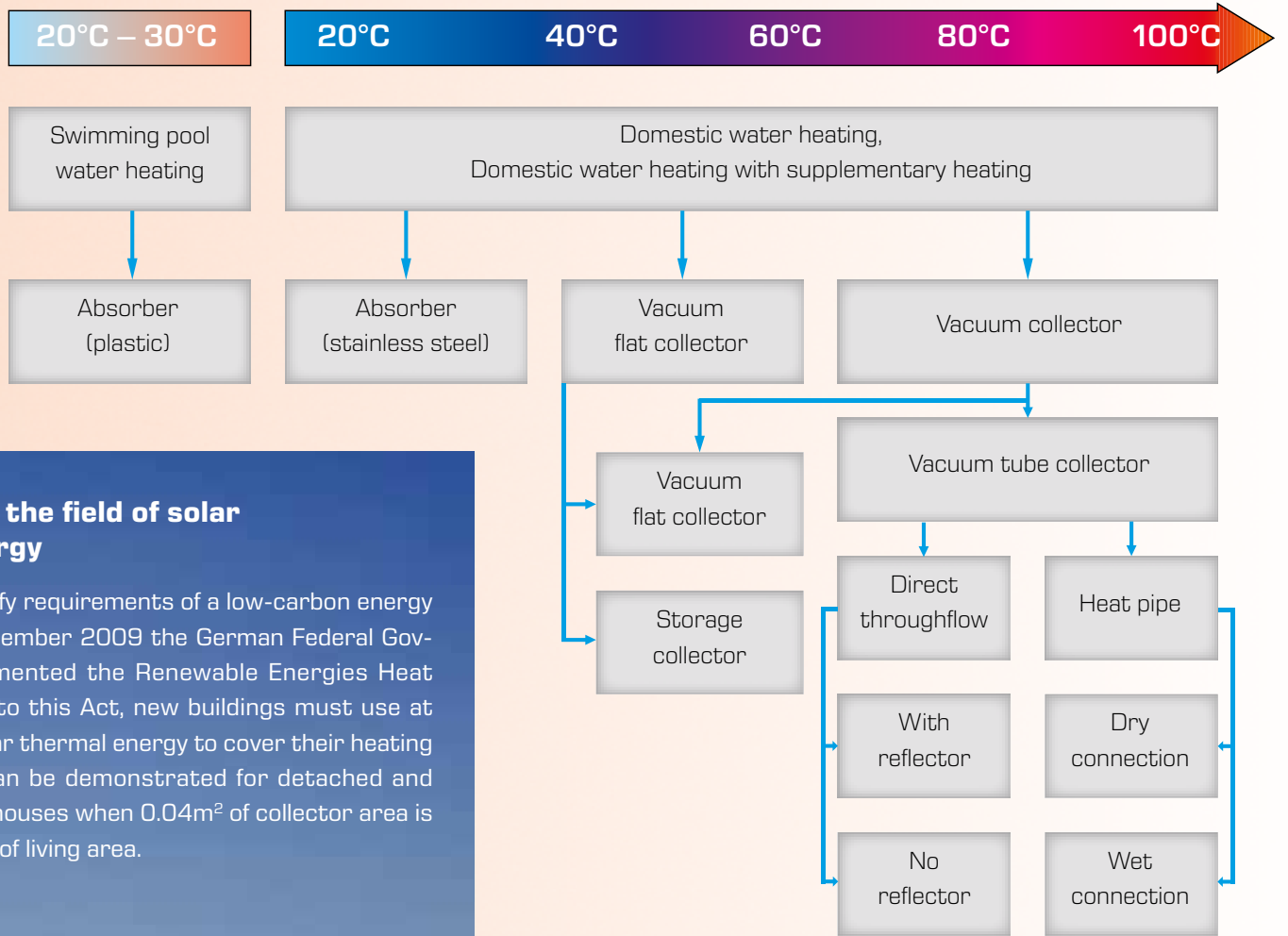

Measures in the field of solar thermal energy

In order to satisfy requirements of a low-carbon energy policy, on 1 September 2009 the German Federal Government implemented the Renewable Energies Heat Act. According to this Act, new buildings must use at least 15% of solar thermal energy to cover their heating demand. This can be demonstrated for detached and semi-detached houses when 0.04m² of collector area is installed per m² of living area.

Proper installation of components by well-trained specialists is an essential requirement for the successful operation of solar thermal systems.

Flat collectors

The most common type of collector is the flat collector, with a market share of approximately 90%. Its strengths lie in its comparatively simple structure and good history of use.

Composition of a flat collector

Inside a flat collector an absorber converts the sunlight into heat and transmits it to the heat transfer fluid. The absorber is located in a casing, which has an effective thermal insulation on the back.

- 1 Absorber
- 2 Glass cover
- 3 Thermal insulation
- 4 Heat transfer pipe

In temperate latitudes, where frost has to be expected for part of the year, the heat transfer fluid has to be protected against freezing. Otherwise, the flat collectors may be irreparably damaged.

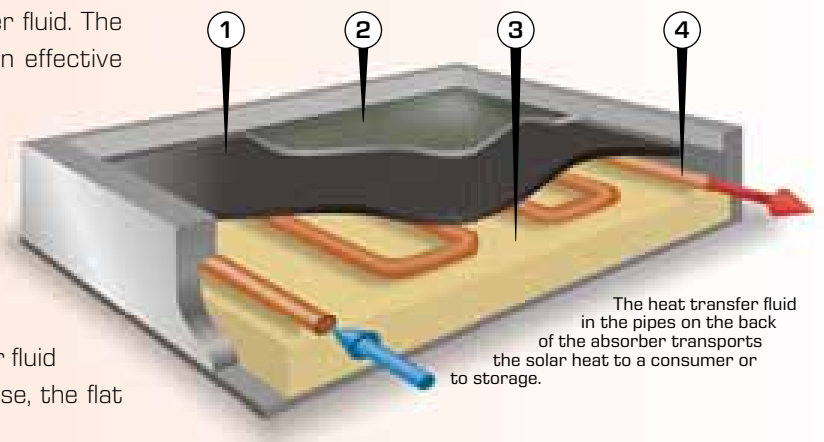

Solar thermal energy: application technology 1

HL313 Domestic Water Heating with Flat Collector

Familiarise yourself with key real-world components from the field of solar thermal domestic water heating with HL313. From the correct filling with a heat transfer fluid to determining and optimising the net power, the didactic concept includes crucial training aspects from theory and practice.

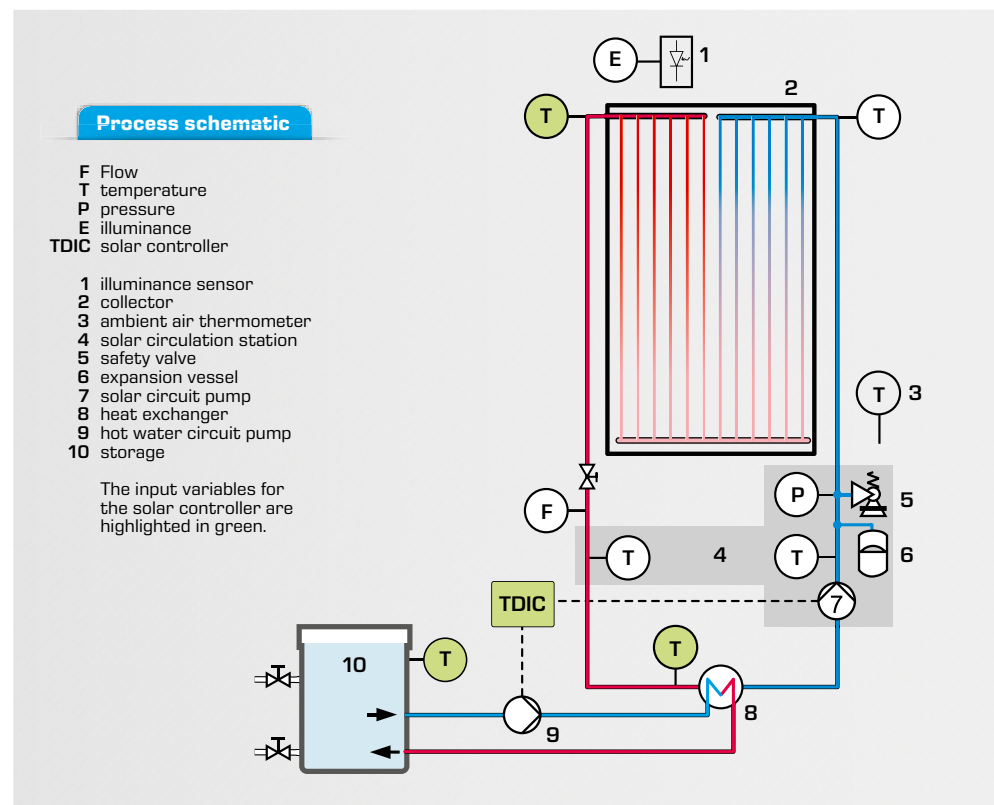

Operating principle

The flat collector absorbs the radiant energy and converts it into heat. The heat is transferred to a heat transfer fluid in the solar circuit. The heat then gets into the hot water circuit via a heat exchanger. The solar controller regulates the pumps in the hot water and solar circuits. The solar circuit is fitted with a safety module, consisting of a diaphragm expansion vessel, a safety valve and a pressure sensor.

The solar circuit station

In addition to the collector, the main components of a solar thermal system are the pump and filling equipment, safety devices and measuring instruments. In practice, these components are often grouped together in what is known as the solar circuit station.

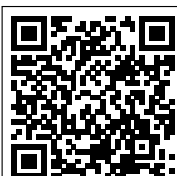

See here for more details and technical data.



The accompanying instructional material

The well-structured instructional material sets out the fundamentals and provides a step-by-step guide through the experiments.

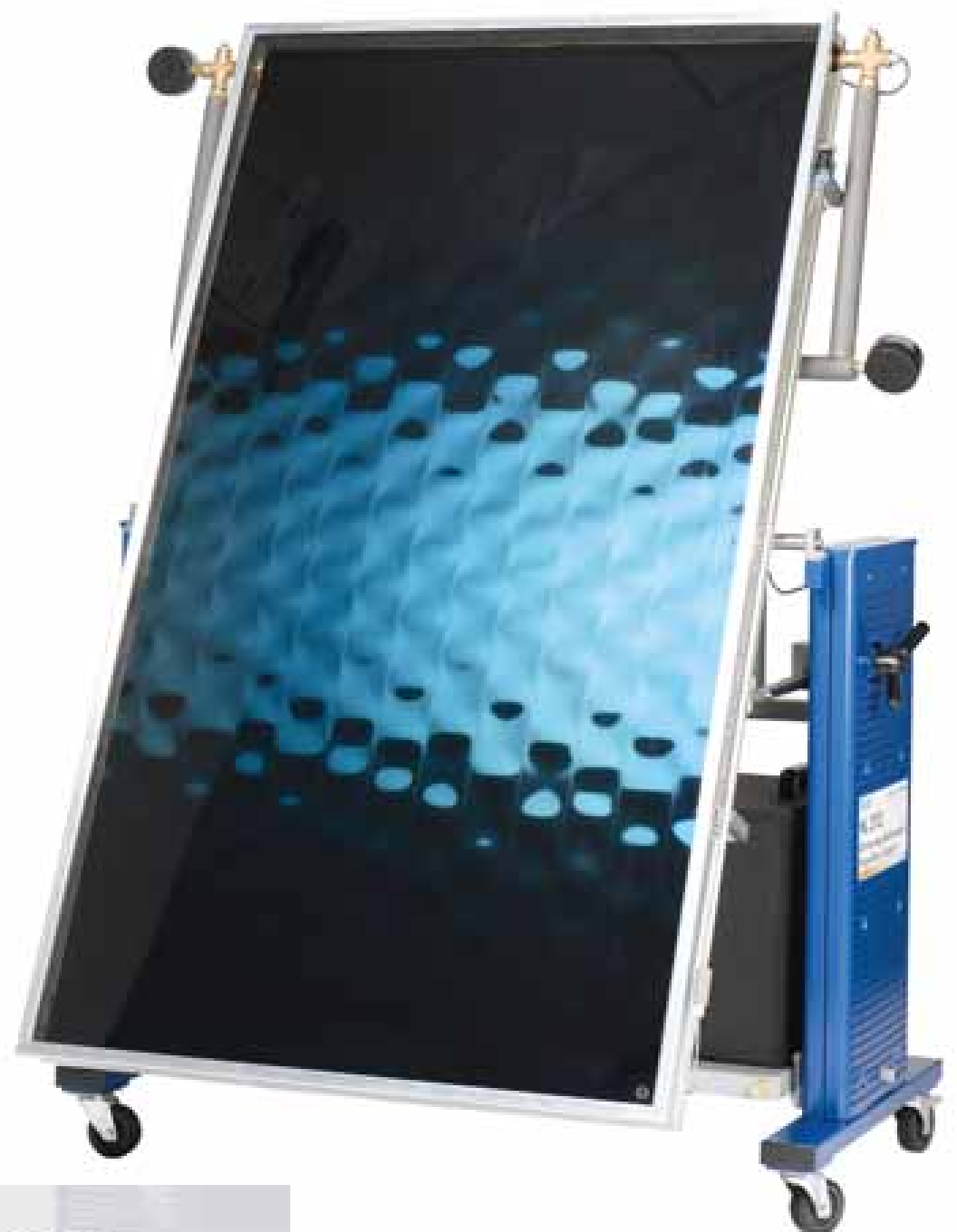

Use in the laboratory with artificial lighting or outdoors when there is sufficient sunlight.

Learning objectives/experiments

- Function of a thermal solar collector and design of the solar circuit
- Function of a solar controller
- How the collector efficiency depends on the temperature difference to the environment
- Determining the net power



Work out the factors affecting the use of thermal solar energy

The sun's energy keeps our environment at an average temperature that is vital in our lives. The sunlight creates temperature differences and thus the requirements for local climate and weather conditions. Comparable effects can be observed in both global and the much smaller dimensions of a solar thermal collector.

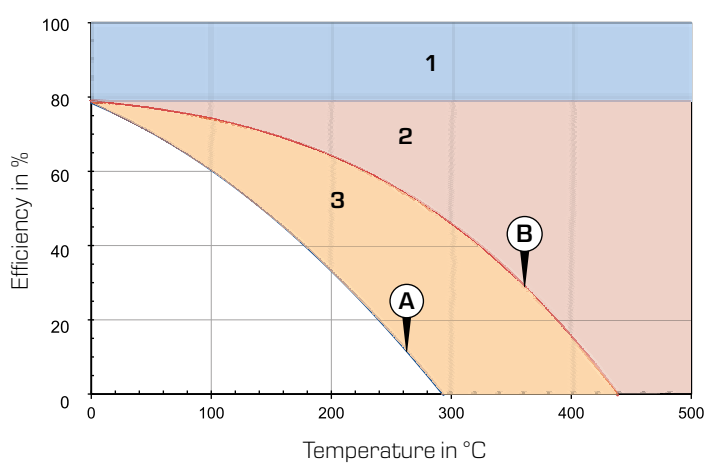

Efficiency curves

It can be shown that collectors achieve the best efficiencies at low temperatures. This is due to an increase in losses as temperature increases.

This behaviour is evident in the efficiency curve of a flat collector (A).

A Measured efficiency curve

B Calculated characteristic with losses by thermal radiation (with no losses due to convection and conduction)

The diagram also shows the temperature dependence of the different loss components, represented by coloured regions:

- 1 Optical losses
- 2 Losses through heat radiation
- 3 Losses through convection and heat conduction

Using the efficiency curve, it is possible to compare the quality and the behaviour of a variety of collectors.

The well-thought out development of the fundamentals of solar thermal energy conversion offers the best condition for the successful operation and targeted improvement of collectors and components.

To understand the fundamentals, it is necessary to consider all individual steps and the interaction between the physical effects involved in detail.

With our trainers on solar thermal energy, we want to help you teach the major aspects from theory and practice in reasonable steps.

Energy balance on the collector

One of the main objectives of collector development is to minimise losses. The proportions of the major loss channels in thermal solar energy use with flat collectors are shown schematically in the following energy balance.

- 1 Absorption in the atmosphere
- 2 Reflection on the glass cover
- 3 Convection
- 4 Radiation losses
- 5 Thermal losses

On the way to the absorber, the sunlight (1) first passes through the glass cover. A part of the incident light is reflected (2). Further losses occur through convection (3), radiation losses (4) and heat transport (5).

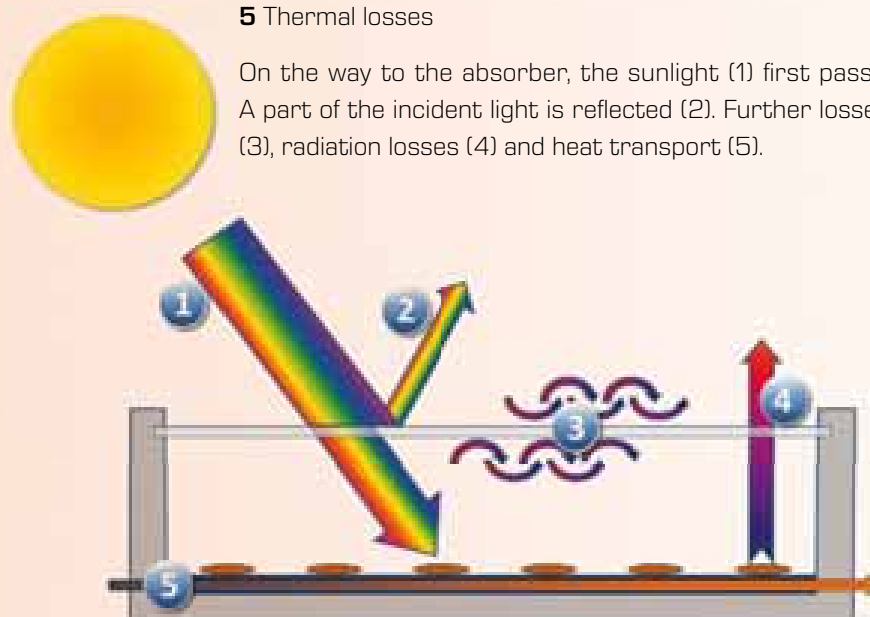

ET 202 Principles of Solar Thermal Energy

The ET 202 trainer allows you to undertake systematic measurements on a solar thermal system with flat collector.

A lighting unit simulates the natural solar radiation. The light is converted into heat in an absorber and transferred to a heat transfer fluid. A pump conveys the heat transfer fluid through a storage tank. There the heat is released to the contents of the tank by an integrated heat exchanger.

The pre-installed absorber with selective coating can be replaced for a more simple blackened absorber, so as to obtain comparative measurements of collector losses. The electric heater (4) in the storage tank (3) shortens the heating times for experiments at higher temperatures.

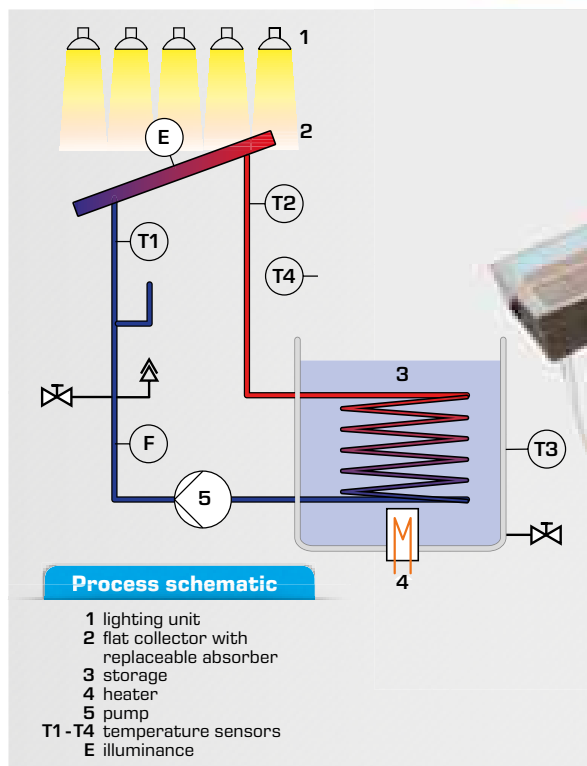

Learning objectives / experiments

- Design and operation of a simple solar thermal system
- Energy balance on the solar collector
- Influence of illuminance, angle of incidence and flow
- Determining efficiency curves
- Influence of various absorbing surfaces

Software

Conducting the experiments is supported by clear software used to display and analyse the measured values.



See here for more details and technical data.

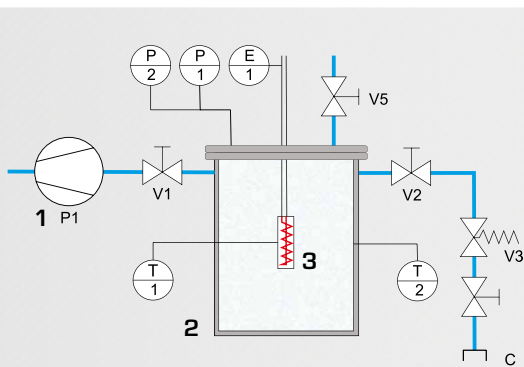

WL 377 Natural Convection and Radiation Apparatus

WL 377 allows you to conduct experiments on heat transfer under different ambient conditions. In this way you can develop the fundamentals of typical heat transfer processes in a thermal solar collector.

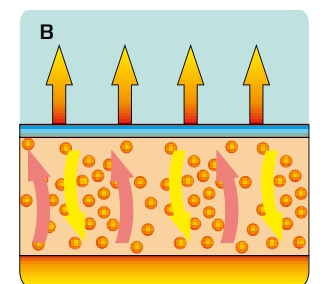
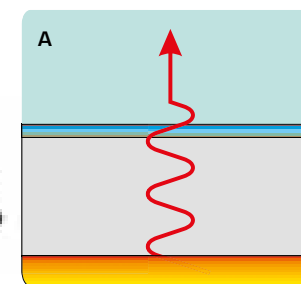

The heat losses of a thermal solar collector can be significantly reduced if the intermediate spaces between the glass cover and absorber are evacuated.

Learning objectives / experiments

- Heat transfer by convection at ambient pressure
- Heat transfer by radiation in a vacuum

Operating principle

While energy at ambient pressure is transported mainly by convection, at very low pressures energy is only transported by radiation.

An electrically heated metal cylinder is located in a pressure vessel which can be evacuated. Low pressures up to 1 Pa absolute are generated via the built-in vacuum pump. Pressures up to 1 bar can be realised via an external compressed air connection.

Pressure and temperatures are shown on the measuring unit. The measured values can be transmitted directly to a PC via USB. The data acquisition software is included.

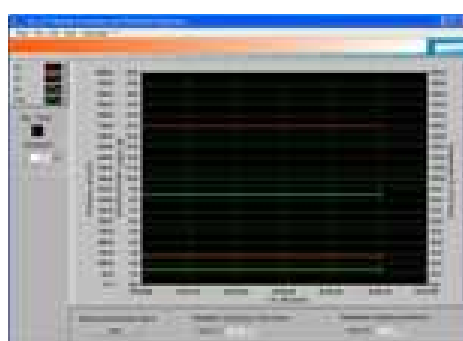

See here for more details and technical data.

Combined use of renewable heat sources

For modern residential buildings with good thermal insulation, in many cases doing away with a conventional heating system represents a genuine alternative. The combination of solar thermal collectors with a heat pump very often guarantees significant savings with reliable year-round supply.

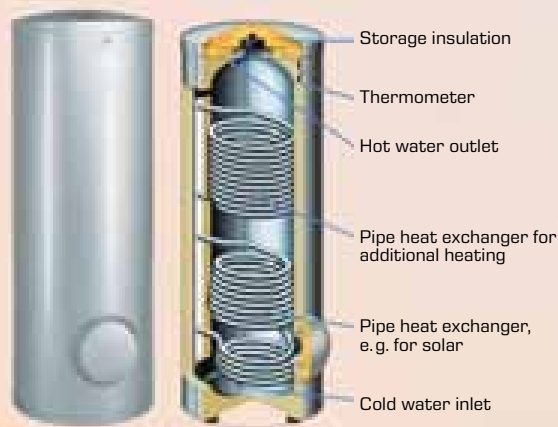

Source: Vießmann



In large heating systems in particular, the combined use of heat pumps and solar thermal energy can result in a significant reduction in costs.

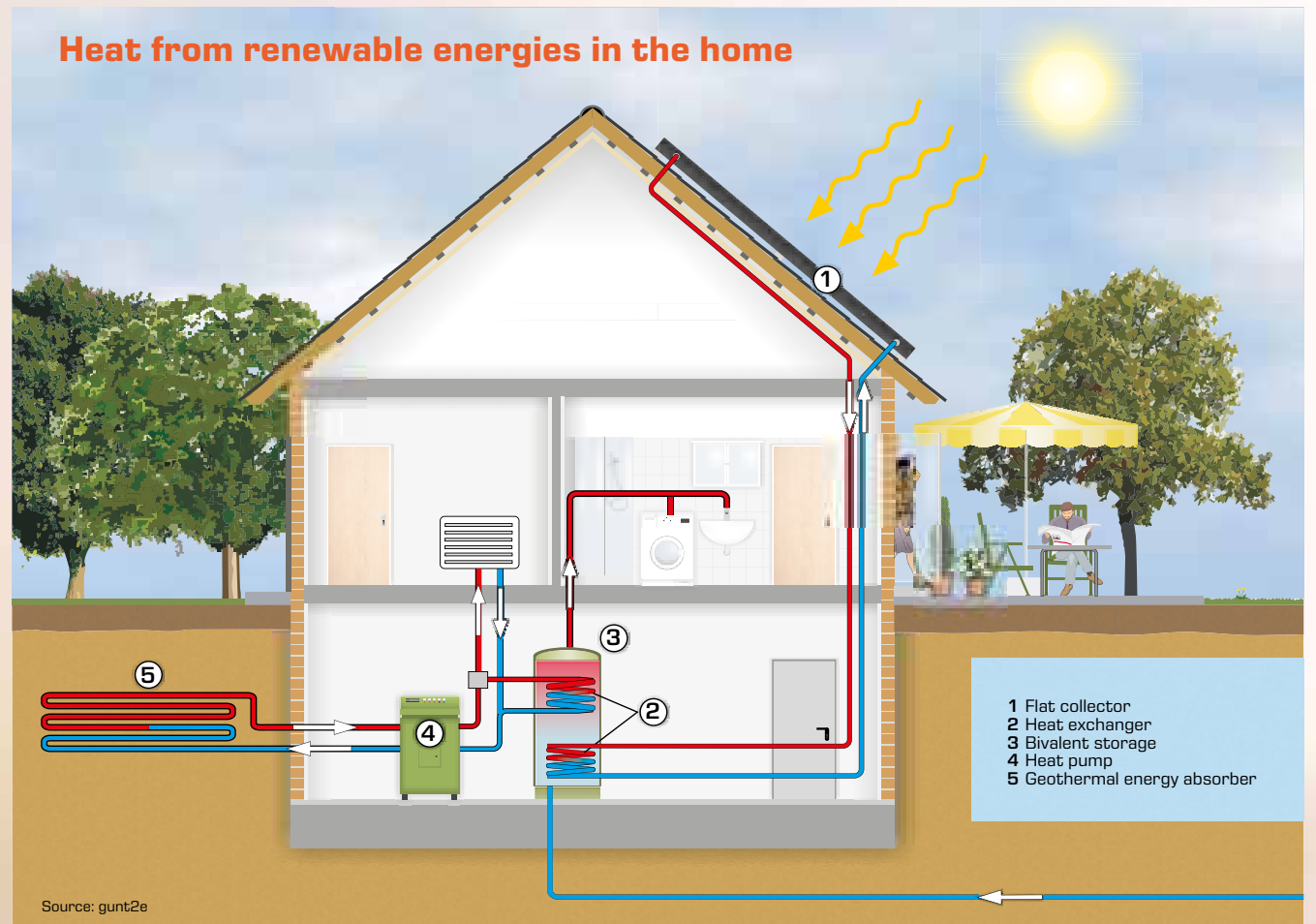

Source: gunt2e

The illustration shows a system for room heating and domestic water heating. The flat collector (1) supports the heat generation, thus reducing the energy consumption of the brine heat pump (4). Heat is supplied to the heat pump by the geothermal heat absorber (5). The bivalent storage (3) enables the integration of different heat sources and creates a balance between heat supply and demand.

Design and coverage

An important criterion in the design of climate-friendly heating systems is the coverage ratio, i.e. the proportion of heat demand to be covered by solar thermal means on average throughout the year.

As shown in the diagram opposite, a higher coverage ratio (A) can be achieved by increasing the collector area. However, this decreases the rate of use (B) of the collector area. In other words, for a given system, as collector area increases the time in which the maximum possible capacity can be fully utilised is reduced.

An economic solution (darker region) is usually achieved with a balanced ratio in the region of the intersection of curves A and B.

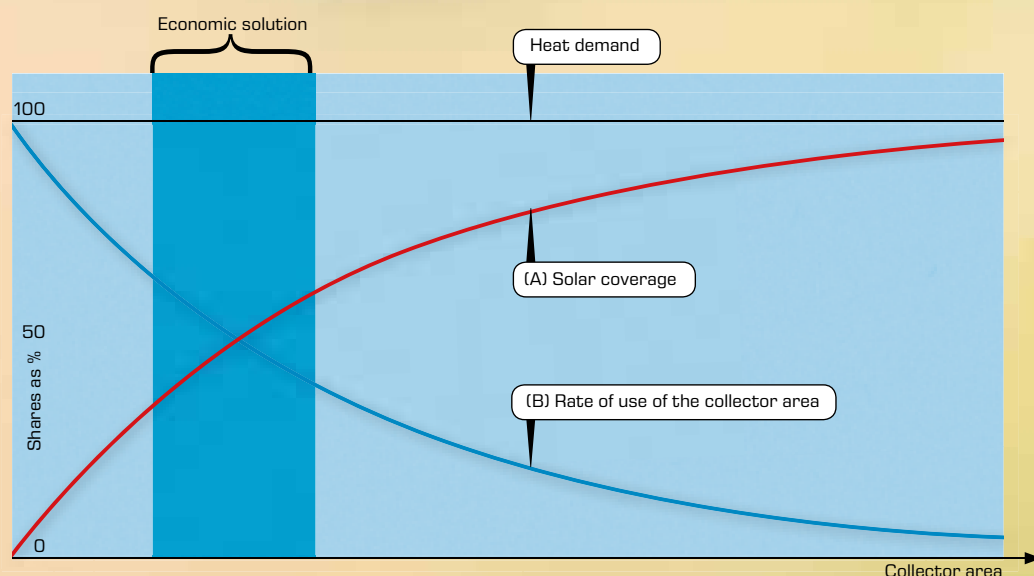

Looking at the graph it is evident that an economical system that can meet demand requires another heat source in addition to the solar thermal energy. To determine which combination of system components is most suitable for this situation, it is necessary to know the behaviour of the components in the anticipated operating conditions.

HL320 Solar Thermal Energy and Heat Pump

HL 320.01

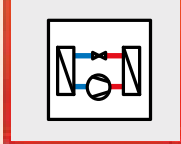

HL 320.02

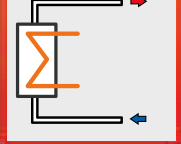

HL 320.03

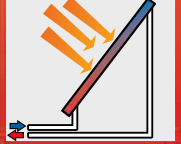

Modules of the HL 320 system:

- HL 320.01 Heat Pump
- HL 320.02 Conventional Auxiliary Heater
- HL 320.03 Flat Plate Collector
- HL 320.04 Evacuated Tube Collector
- HL 320.05 Central Storage Module with Controller
- HL 320.07 Underfloor Heating/Geothermal Energy Absorber
- HL 320.08 Fan Convector as Load or Heat Source

The individual modules can be quickly and easily connected. This makes it possible to investigate different system concepts in a short time with the same modules.

HL 320.04

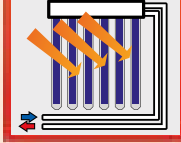

HL 320.05

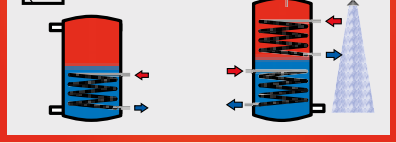

HL 320
Solar Thermal
Energy and Heat
Pump Modular
System

HL 320.07

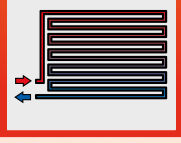

HL 320.08

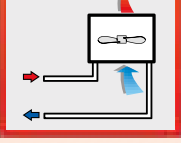

The HL 320 modular concept

The HL320 modular concept has been developed in order to study various combinations of traditional and renewable heat sources as well as storage methods and consumers.

The system uses typical real-world industrial components from the field of modern heating technology.

The modular system is part of the overall 2E concept in the renewable energy sector.

Investigate different configurations for solar thermal energy and heat pumps with HL 320

System with heat pump and flat collector

The process schematic for a typical system with heat pump and flat collector is shown in the figure below:

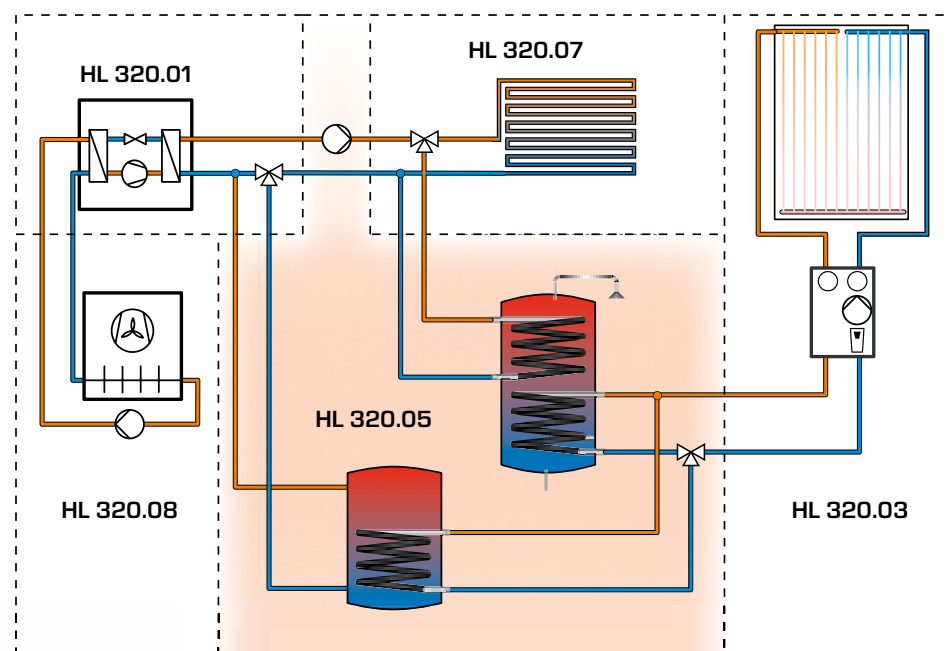

In this configuration, the HL 320.08 Fan Convector is used as the heat source for the HL 320.01 Heat Pump. The HL 320.07 module is included as a heat sink (underfloor heating).

The HL 320.05 storage module

The base unit with buffer storage and bivalent storage

The HL 320.05 storage module is a central module for all intended experiments. It has a buffer storage and a bivalent storage. Other components of this module include:

1. A programmable controller
2. Pressure relief valve and bleed valve
3. Pressure sensor
4. A pump
5. Temperature sensors on pipes, heat exchangers and at different positions in the interior of the storage tank
6. A driven three-way valve

Both the connections to individual components and to the storage tank are fitted with their own supply lines and shut-off valves in order to make it easier when changing the piping route.

The pump and the three-way valve can be controlled by appropriately configured controller outputs.

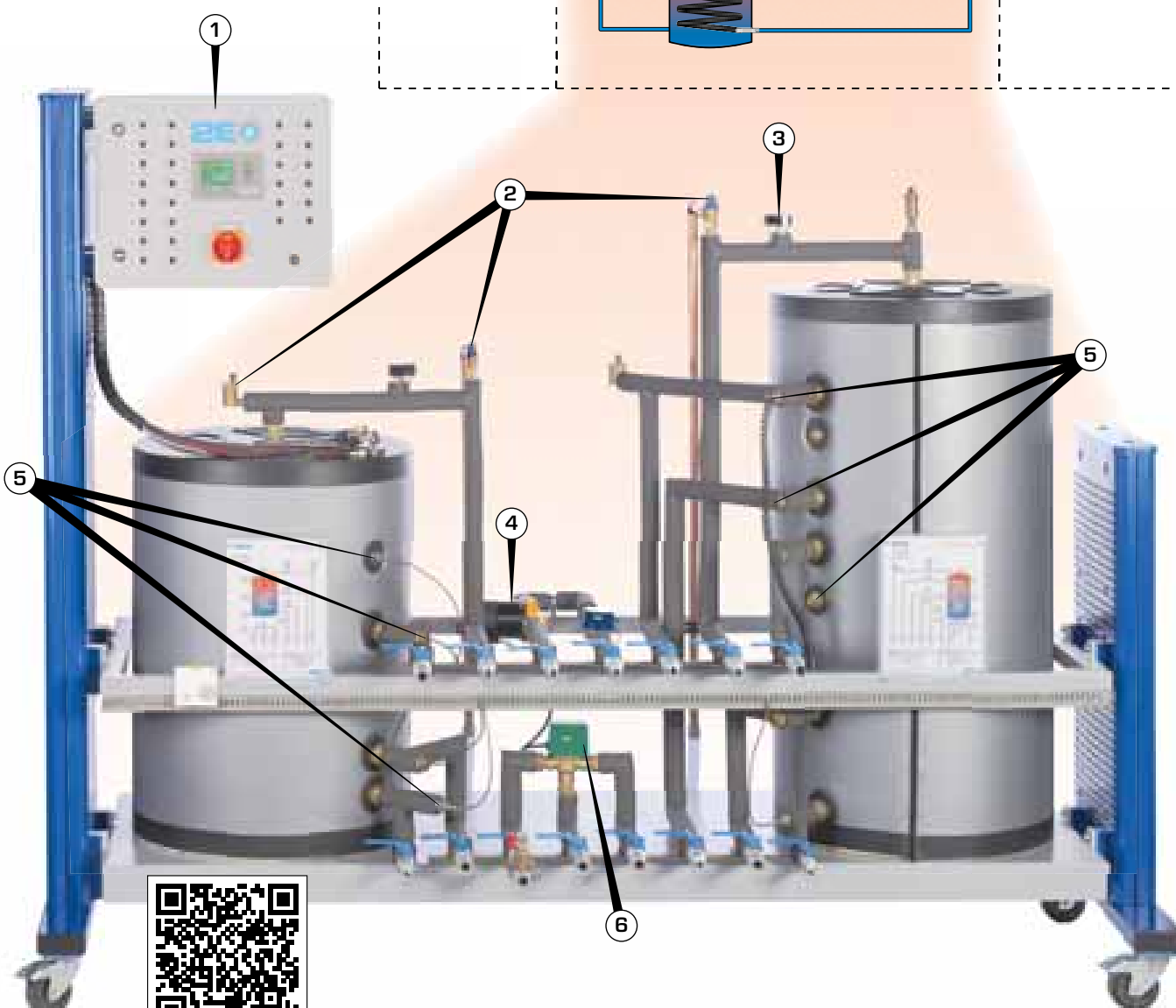

See here for more details and technical data.

HL 320.05 Freely programmable universal controller with data logger and comprehensive software

The HL 320.05 Central Storage Module is equipped with a programmable controller. When preparing for an experiment, the required measurement lines and control lines of the HL 320 modules can be connected to the controller inputs and outputs in accordance with the instruction manual.

Prepared configuration files can then be activated from the controller's internal memory to configure the controller correctly. Thoroughly documented configuration files for introductory and advanced experiments are available. Newly created configurations or changes can be stored in the controller's memory.

A freely available software called Tapps enables PC-based configuration of the controller and using this is much simpler than editing settings via the controller's user elements. Tapps provides full access to pre-defined and self-developed controller functions. As shown in the following figure, the program also offers the possibility of saving charts of the current system schematic in the relevant configuration file (1).

The controller also contains a data logger so that all relevant measured values can be recorded and transferred to the PC for later analysis. A comprehensive software package is also available for data acquisition, transmission (2) and representation (3) (including export function to Microsoft Excel format).

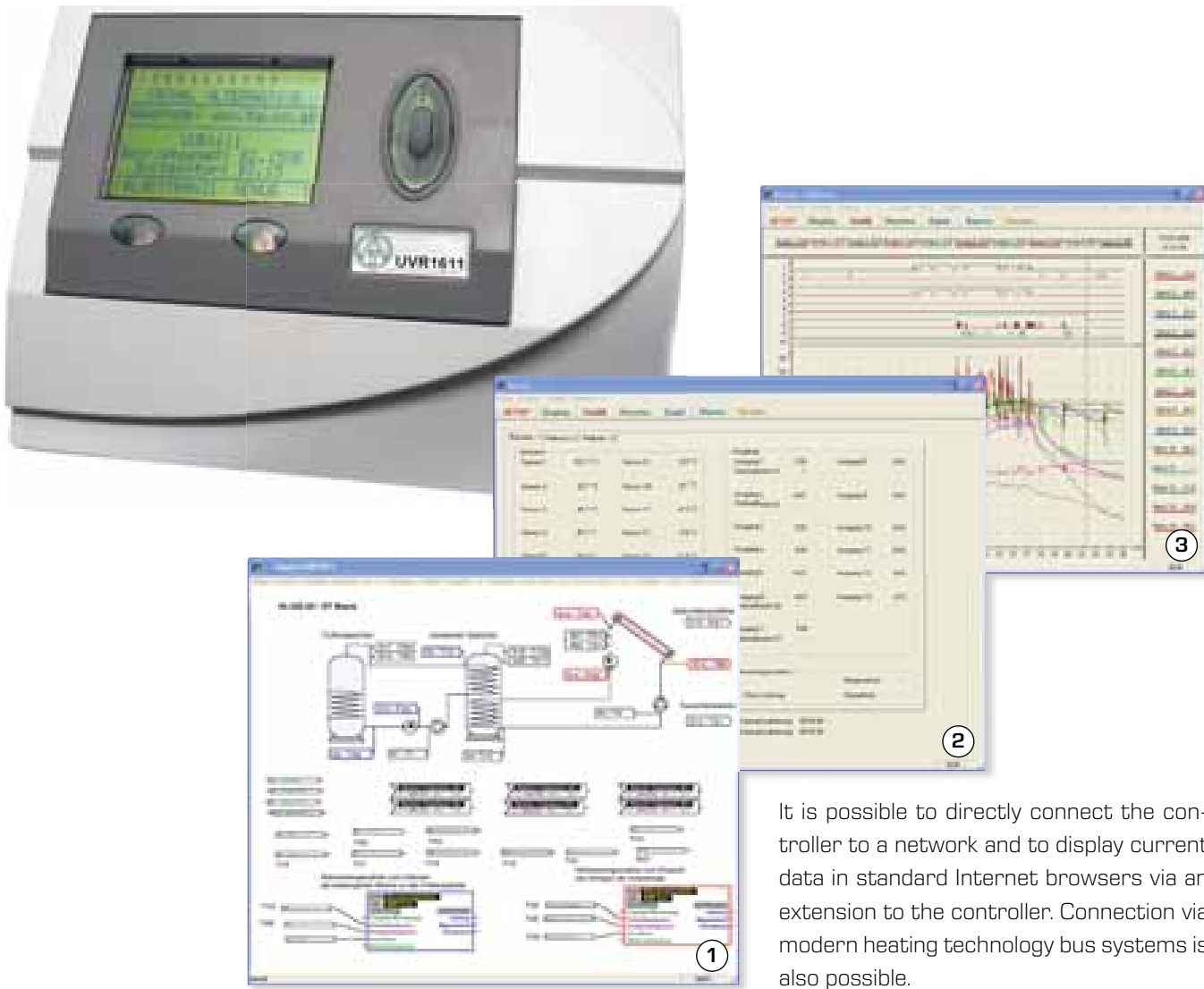

It is possible to directly connect the controller to a network and to display current data in standard Internet browsers via an extension to the controller. Connection via modern heating technology bus systems is also possible.



The HL 320.03 Flat Plate Collector

The HL 320.03 Flat Plate Collector is designed as a module for the HL 320 modular system. This module contains a solar circuit station with a controllable pump. A diaphragm expansion vessel equalizes pressure fluctuations in the solar circuit. Various temperature sensors and a flow meter allow you to measure the solar heat flows. Measurement lines and control lines allow connection to the central controller on the HL 320.05 Storage Module.

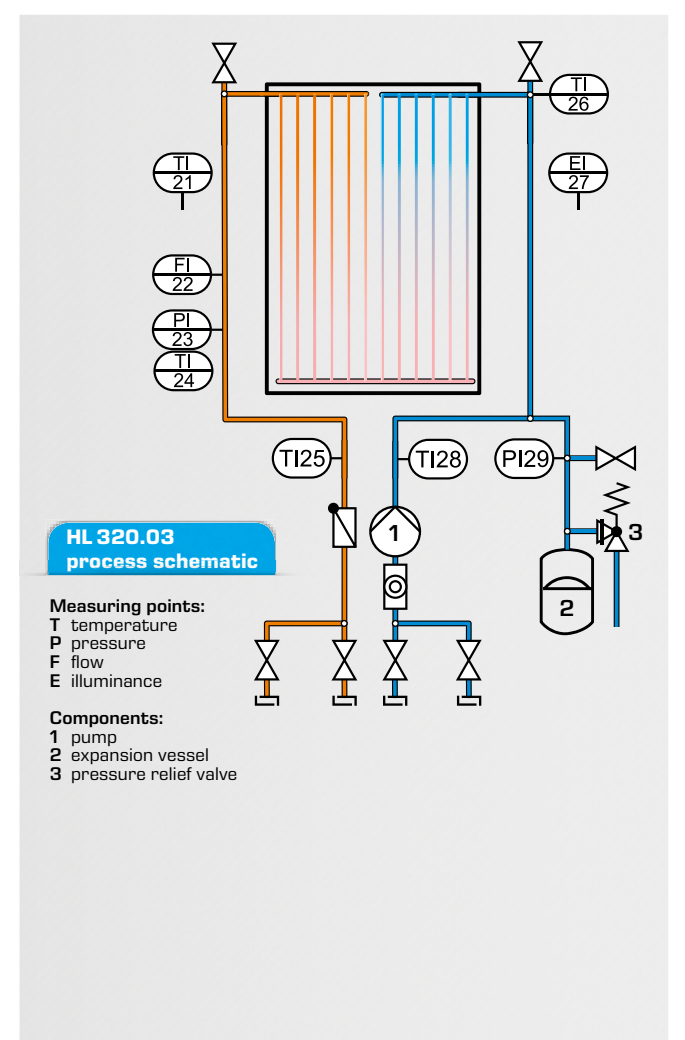

HL 320 Configurations

HL 320 Solar Thermal Energy and Heat Pump Modular System

	Configurations				
	ST Base	ST Max	HP Base	ST HP	ST HP Max
HL 320.01 Heat Pump			X	X	X
HL 320.02 Conventional Heater		X			X
HL 320.03 Flat Plate Collector	X	X		X	X
HL 320.04 Evacuated Tube Collector	(X)	(X)		(X)	(X)
HL 320.05 Central Storage Module with Controller	X	X		X	X
HL 320.07 Underfloor Heating / Geothermal Energy Absorber		X	X	X	X
HL 320.08 Fan Heater / Air Heat Exchanger			X	X	X

The modules can be assembled into different configurations depending on the learning objective. The abbreviation "ST" in the configurations name stands for Solar Thermal and "HP" for Heat Pump. The extension "base" indicates an entry configuration whereas "max" is used for more complex configurations. The main unit is the central storage module with the freely programmable universal controller.

The HL 320.04 Evacuated Tube Collector can be used as an alternative to the HL 320.03 Flat Plate Collector. Particularly efficient system concepts can be determined through comparative series of measurements with different experiment setups.



HL 320 base configuration for experiments on water heating and collector tests

Learning objectives / experiments

- Familiarisation with modern heating systems based on renewable energy sources
- Commissioning of heating systems with solar thermal energy and heat pumps
- Learn about electrical, hydraulic and control engineering operating conditions
- Properties of various heat storage methods
- Parameters for the efficiency and capacity of solar thermal collectors
- Parameters for the efficiency and capacity of heat pumps
- Energy balances for different system configurations
- Requirement profiles for domestic water heating and room heating
- Control strategies for different operating modes

Planning for your solar energy laboratory

Useful combinations of 2E devices

Of course your choice of 2E experimental units for solar energy also depends on individual local factors. However to help you, we would like to offer an overview on the useful combination of available experimental units. This overview is intended as a guideline when you are planning to acquire your training units in a step by step process over a longer period of time.

2E Photovoltaic experiments									
Extension levels	Laboratory variant A					Laboratory variant B			
	I	II	III	IV		I	II	III	IV
	Step-by-step to the complete laboratory →					Step-by-step to the complete laboratory →			
ET 250	+					+			
HL 313.01		+					+		
ET 252			+					+	
ET 250.01				+					+
ET 250.02				+					+
ET 255									+

2E Solar thermal experiments													
Extension levels	Laboratory variant A						Laboratory variant B						
	I	II	III	IV	V		I	II	III	IV	V	VI	VII
	Step-by-step to the complete laboratory →						Step-by-step to the complete laboratory →						
HL 313	+												
HL 313.01		+						+					
ET 202			+								+		
WL 377				+								+	
HL 320 ST Base*							+						
HL 320 ST Max*								+					
HL 320 HP Base*					+				+				
HL 320 ST HP*									+				
HL 320 ST HP Max*										+			

* (cf. Table on p.19)

As shown in the tables above, we would recommend two different laboratory variants (A, B) for the fields of photovoltaics and solar thermal energy. Which variant is appropriate depends on factors like available laboratory space, intended education level and financial budget.

For each laboratory variant the table starts with a recommendation for the introductory unit (level I). The subsequent columns of the table indicate the recommended sequence of useful extensions (levels II-VII). For each column (extension level) there is at least one field marked by a cross with a darker background. This field indicates the experimental unit that is recommended for acquisition in order to complete that level. Following these recommendations step by step, ensures a well-balanced building up of your laboratory equipment up to the final extension stage.

In this way you have the option of gradually procuring your desired configuration of equipment. The specific combinations guarantee a thought through extension of the experiments in the 2E curriculum on solar energy with each extension level.



Engineering for a more sustainable society
www.gunt2e.de



Imprint

Published by:
G.U.N.T. Gerätebau GmbH
Hanskampring 15 - 17
D-22885 Barsbüttel
Telefon: +49 40 / 670 854 - 0
Internet: www.gunt2e.de

Managing Director:
Rudolf Heckmann

Expert team:
Dr. K. Boedecker

Editorship:
Rudolf Heckmann

Layout:
Profi-Satz

Any reuse, storage, duplication and reproduction of content – even in extracts – is prohibited without the written approval of G.U.N.T. Gerätebau GmbH. No liability is assumed for any unsolicited text and photographic material submitted.

08.2013