

HM 124 Fluid mechanics experimental plant



HM 124 experimental plant in laboratory with optional pressure controlled system via a pressure vessel

This complex experimental plant consists of several modules: a pump station, two measuring sections, a control station, a tank system and an optional pressure controlled system. The modules themselves include a number of components: centrifugal pumps in different sizes, various valves, level and pressure controllers, pipes of different diameters and surface roughness, control valves and fittings, pipe fittings and various tanks to name a few.

The interaction of the various components determines the fluidic behaviour of the overall system. The individual processes interact with each other, resulting in interactions that affect the entire system. This effect occurs in all real, industrial plants. Studying the individual components does not reflect reality. In order to obtain comparable, objective measuring results on individual components, certain conditions must be met. For example, certain inlet and outlet sections are required for the measurement of valve characteristics.

This aspect has been taken into consideration when planning and designing the HM 124 experimental plant, so that objective measuring results can be achieved. The components are matched to each other to largely minimise the mutual interaction and influence of the processes on the individual components. This means rigorous experiments from the field of fluid mechanics can be performed. The system is also ideally suited for scientific investigations.

Experiments and learning objectives

- experiments on pumps, valves and fittings and pipes
- operating behaviour of centrifugal pumps in stand-alone or parallel operation
- recording pump characteristics
- determining pump efficiencies
- influence of system characteristic on flow rate and operating point of the pumps
- measurements of pressure losses in pipe bends and in pipes of different roughness
- measurements of the velocity distribution in pipes
- visualization of the pipe flow
- determination of loss coefficients in fittings
- recording of opening characteristics and K_v values
- adjustment and maintenance on valves
- experiments on flow and pressure control loops

The use of industrial components and measurement techniques teaches great practical relevance

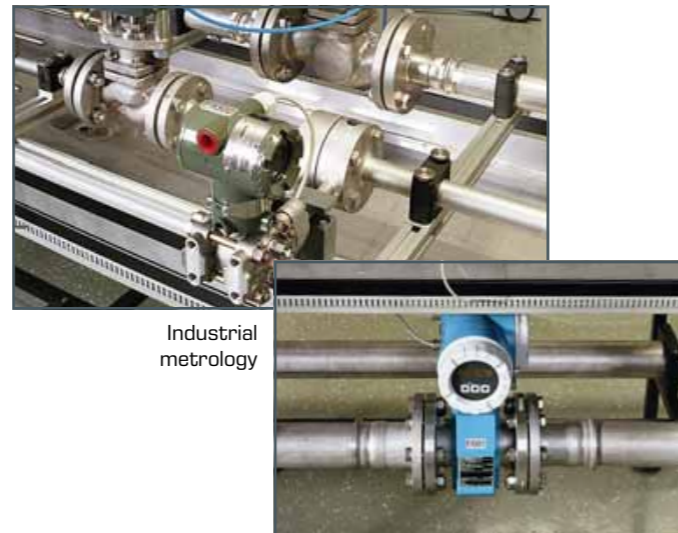

Industrial metrology



Industrial components



There are two different sized centrifugal pumps available for investigations on pumps.



The individual design of the measuring section offers the user a wide range of experiments.

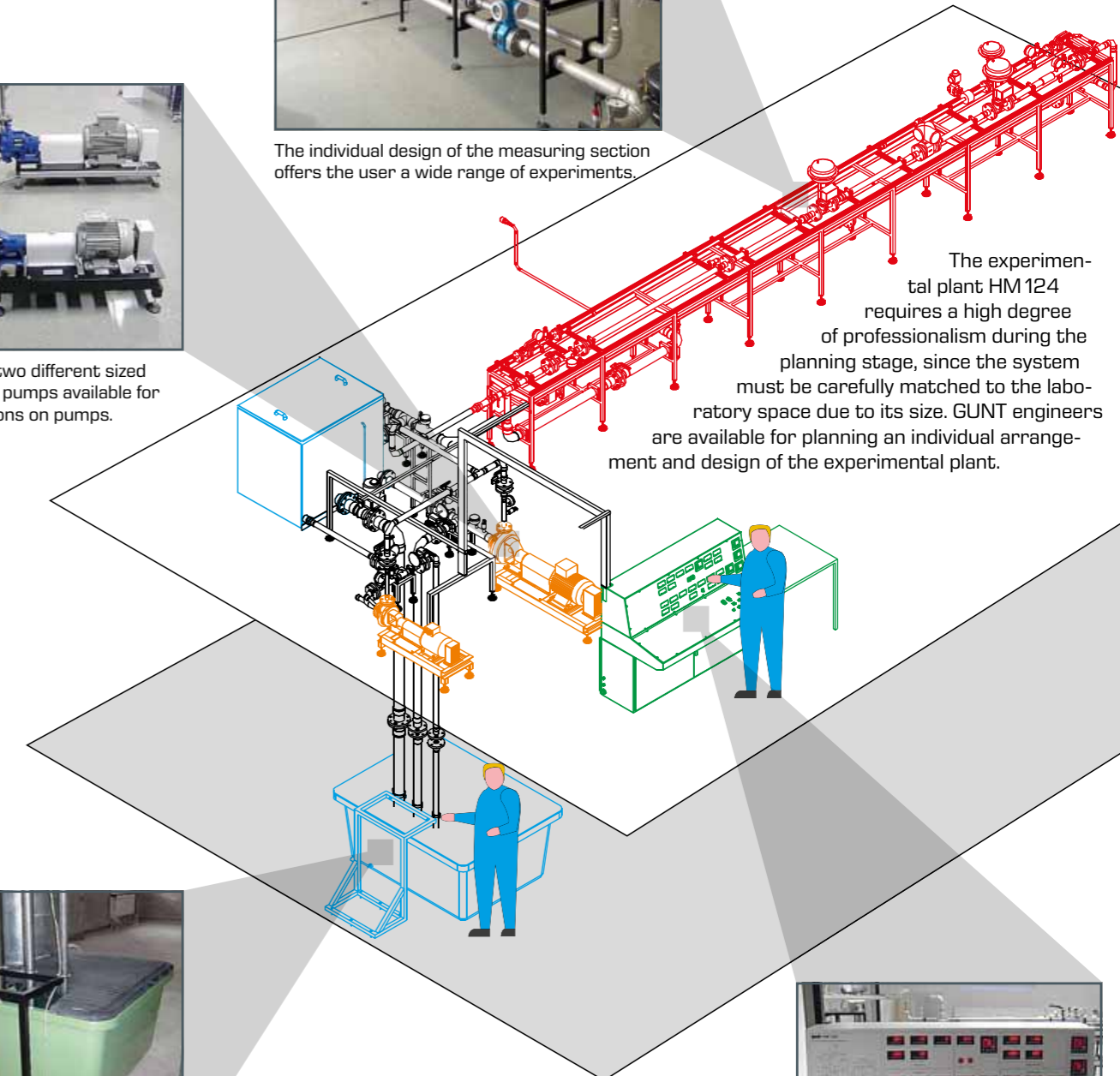

The experimental plant HM 124 requires a high degree of professionalism during the planning stage, since the system must be carefully matched to the laboratory space due to its size. GUNT engineers are available for planning an individual arrangement and design of the experimental plant.



If there is sufficient space available, a second intake tank may be added on the floor below the experimental plant. The resulting greater suction head makes it easier to conduct series of experiments on the operating behaviour of a pump in relation to the NPSH and cavitation.



The industrial scale control console ensures a clear and convenient operation.

HM 124 Fluid mechanics experimental plant

HM 124 measuring section components

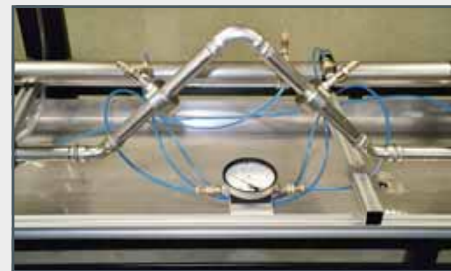

Measurement of pressure losses at 45° and 90° pipe bends.

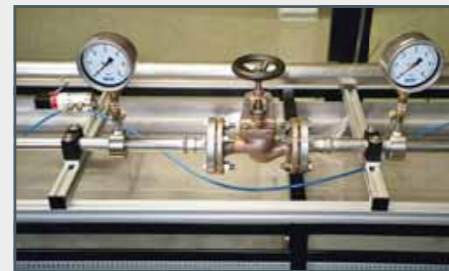

A corresponding measurement station has been incorporated into the measuring section to record a valve characteristic.

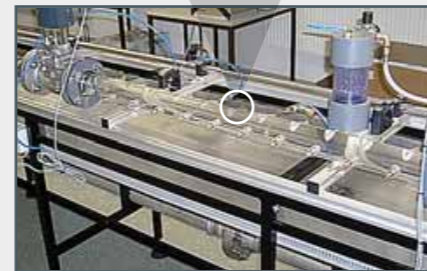

A transparent measuring section and a contrast agent means flows can be visualised.

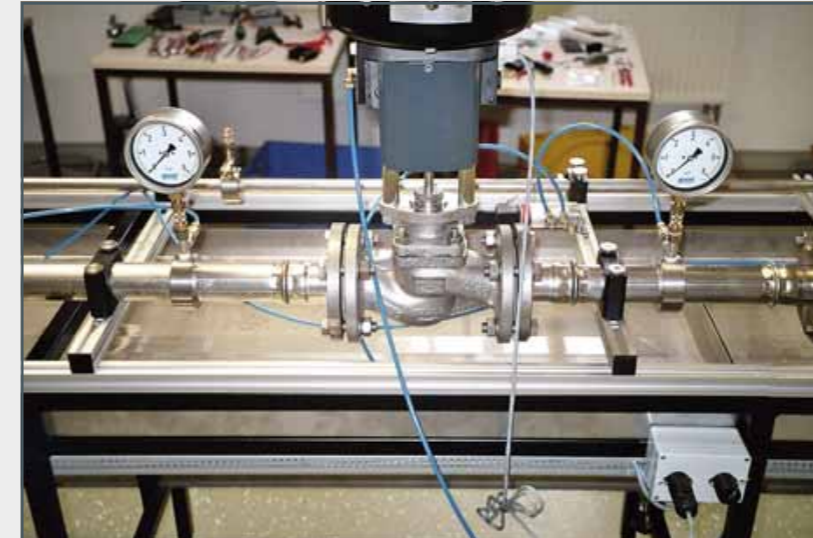
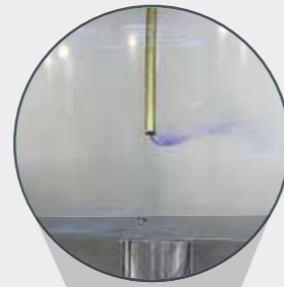

Measurements for determining the K_v value are conducted on an industrial control valve. Other valves with standard flanges (not included) can be installed and studied.



Pipe sections with different diameters and made from different materials are available for measuring pressure losses. In addition to hydraulically smooth pipe sections there is also a pipe section with a defined roughness.

The experimental plant has two parallel measuring sections with nominal diameters of DN25 and DN50.

The individual pipe elements can easily be removed and installed by means of flanges. This means it is possible to construct individual pipe section configurations. Each measuring section is fitted with a valve at the inlet and outlet. When redesigning the plant, any water that escapes is collected in a pan below the measuring section.

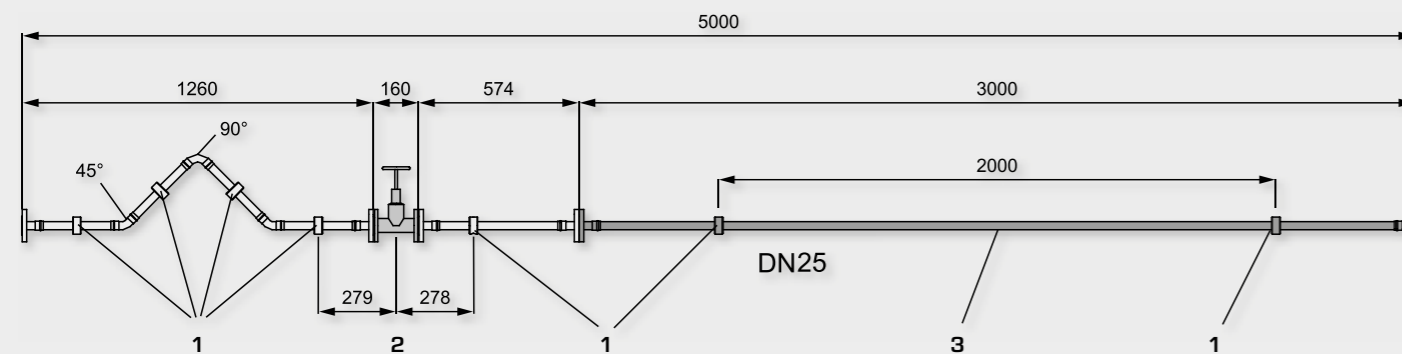

1 measuring points for pressure losses in pipe elements, 2 measuring range for shut-off element, 3 defined pipe section with DN25 for measuring pipe friction coefficients

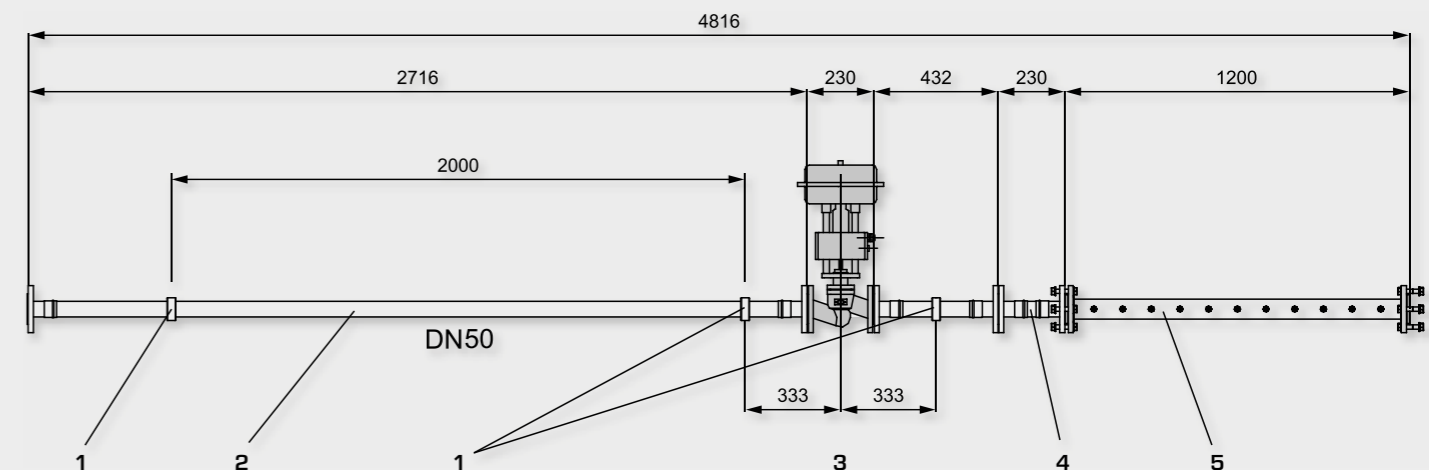

1 pressure measuring points, 2 defined pipe section with DN50 for measuring pipe friction coefficients, 3 measuring range for K_v value valve test, 4 pipe element or flow straightener, 5 transparent pipe used for observing the reduction of vortices after disturbances

HM 124 Fluid mechanics experimental plant

Pump station of HM 124

The two pumps in the pump station are operated from the control station. The speed can either be adjusted manually or automatically controlled.

The operating behaviour of pumps is studied. In conjunction with the software, it is possible to record characteristics at a constant speed and fixed efficiency. The collected data is

used to determine characteristic fields for the pumps. The diagram below shows an example of system characteristic of a pump station with the operating points 1 and 2. The pump characteristics at different speeds are highlighted in blue, the efficiency in green.



HM 124 pump station

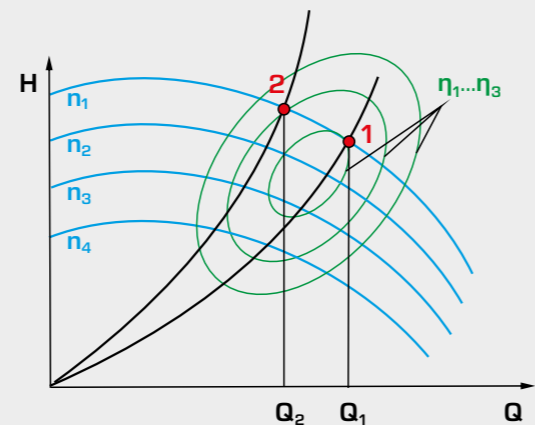

H head, Q flow rate, η efficiency, n speed, 1 + 2 operating points;
■ pump characteristics, ■ efficiency

Control station of HM 124



Transfer of measured data to a PC



HM 124 control station

All electronic displays and controls are housed in the control station. The experiments can be conducted manually or automatically. The measured values are displayed on digital displays on the control console. Data acquisition and the related GUNT software can be used to clearly display the measured data on a PC. Upon request, all measurement data is available as standard electrical signals (0-10V, 4-20mA).

Data acquisition of HM 124

The software has its own sub-schematics available for the various experiment options.

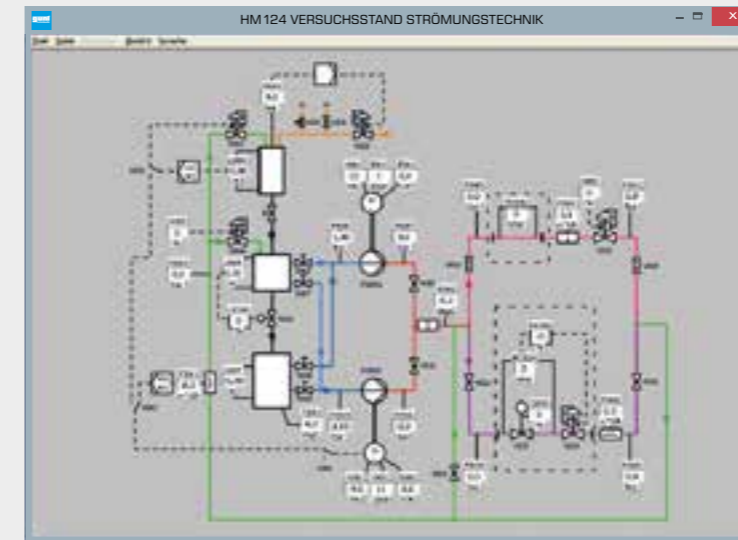

All of the measured values from the experimental plant HM 124 are shown in an overview schematic on the PC, giving a quick summary.

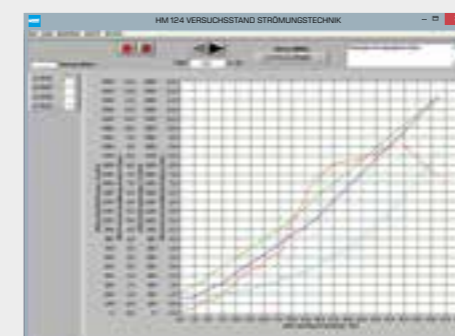

Measurement data can be evaluated quickly and clearly via the software and displayed graphically.

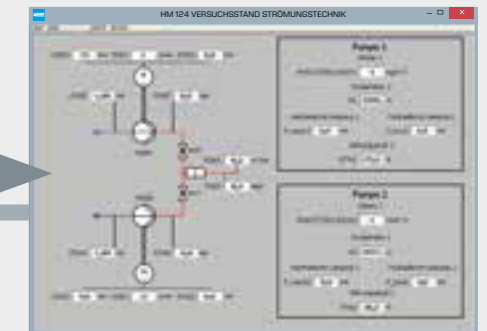

Record operating behaviour of pumps

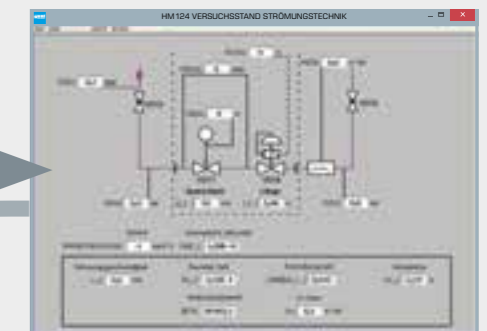

Determine opening characteristic and K_v values at valves and fittings and control valves

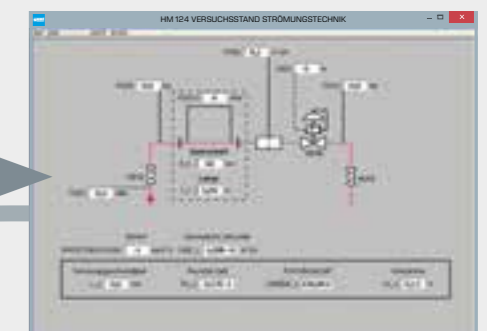

Measure pressure losses in pipe sections and pipe elements

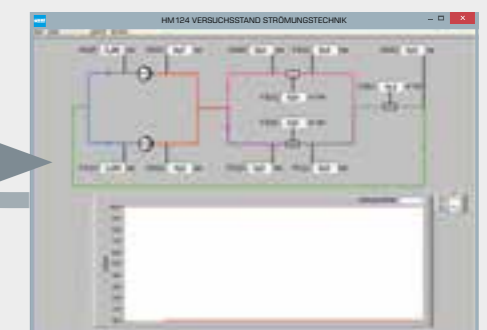

Record system characteristics