

SE 200 | MEC Line Engineering mechanics



Didactic concept for experiments in statics and strength of materials

- smart, communication-enabled components
- wireless digital connection

Table of contents

Didactics and methodology	04
Smart data flow	06
Structure of the MEC Line	08
Smart components	10
Accessories	12
SE 200.01 MEC – Forces in trusses	14
SE 200.02 MEC – Forces on a suspension bridge	16
SE 200.05 MEC – Cable forces and pulley blocks	18
GUNT Science Media Center	20

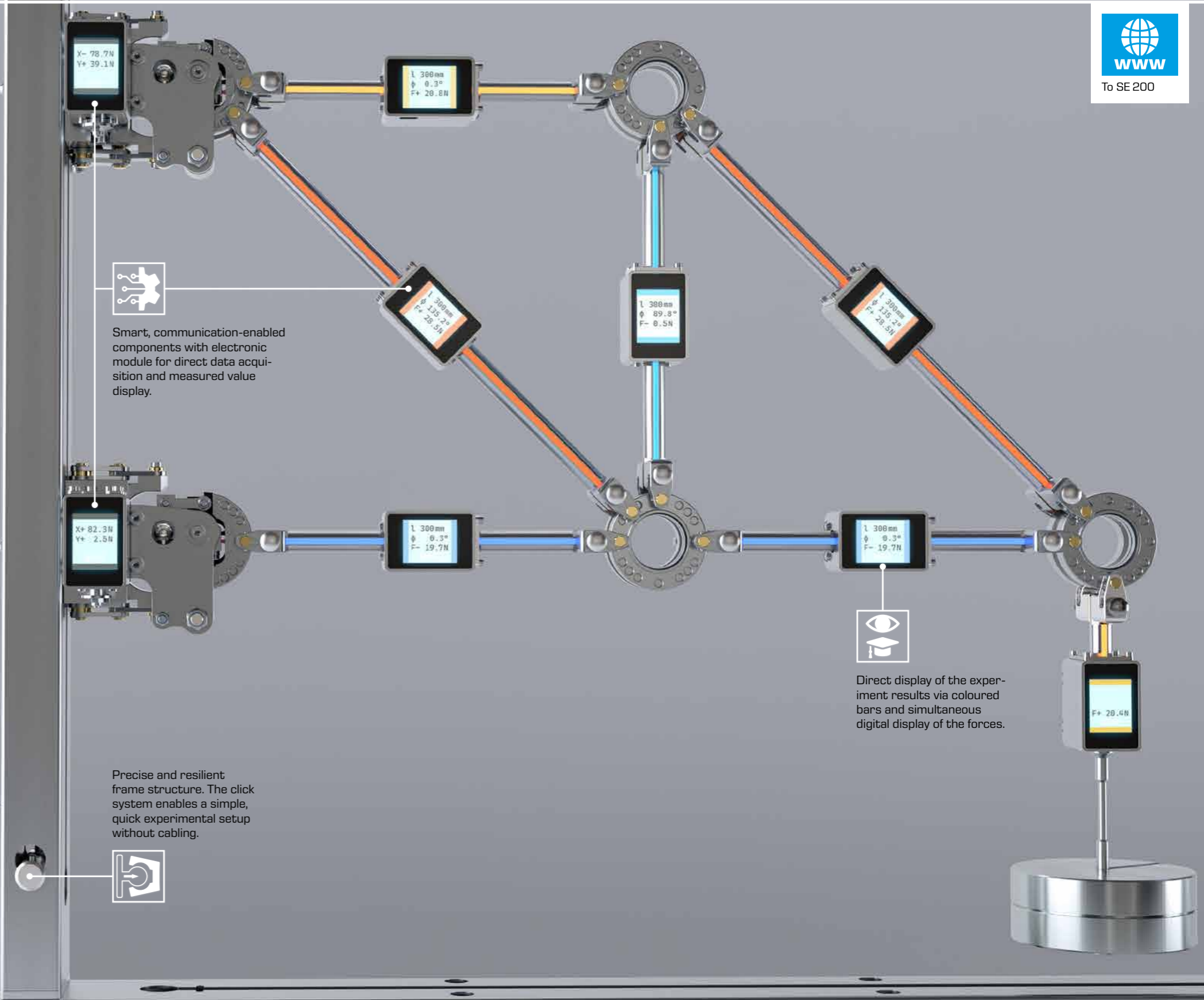

Smart, communication-enabled components with electronic module for direct data acquisition and measured value display.



Direct display of the experiment results via coloured bars and simultaneous digital display of the forces.



Precise and resilient frame structure. The click system enables a simple, quick experimental setup without cabling.



Custom GUNT software with content adapted to the individual experiments enables real-time display and analysis.



The GUNT Science Media Center provides technical descriptions, manuals, exercises, videos and E-Learning courses with fundamental knowledge, theory and calculations for all experiments.

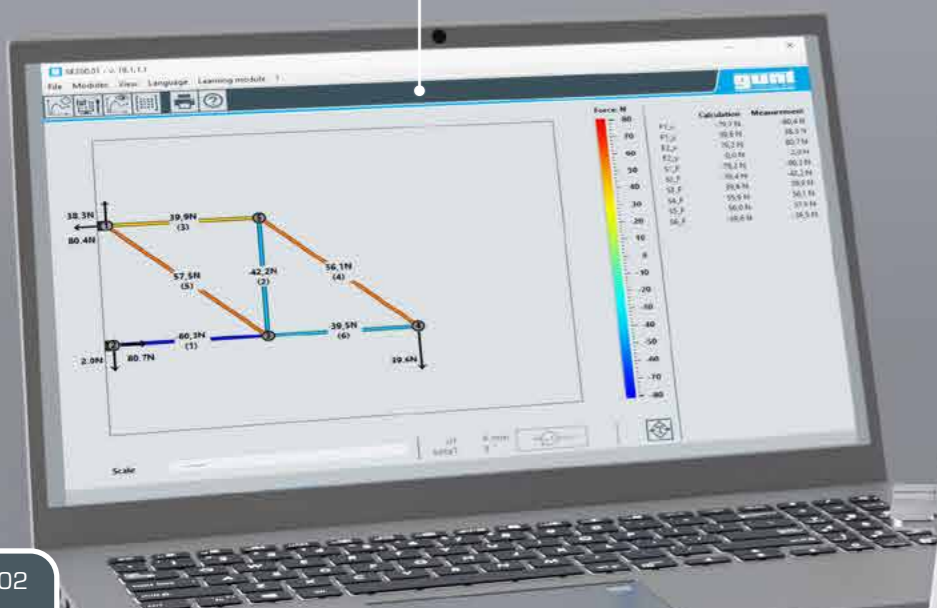

Didactics and methodology

Experiments using all the senses – for an in-depth learning experience

Develop the fundamentals of engineering mechanics according to textbook and curriculum in experiments

What

- static systems in equilibrium of forces
- trusses: internal reaction and support reaction under external loads
- elastic reactions under external loads
- analysis of typical elements from civil engineering: beams, bridges
- familiarisation with stability problems

Familiarisation with digital concepts and methods of measurement technology and data processing simultaneously

How

- implement theoretical teaching topics in experiments by planning series of experiments and setting up your own experiments
- technically realise terms such as fixation or articulated support
- coloured display of forces, display of the loading as well as automatic topology transmission for direct feedback
- microprocessor-based measurement technology for force and angle, distance, position and identification
- application of Gray codes (reflected binary, RB)
- integration of FEM models, strength verification, etc.



Haptic experience

- promotes the comprehension and internalisation of learning content through the sense of touch
- manual work and skill in setting up experiments
- no disruptive cabling of the individual elements
- sturdy components with click system, quick and easy to assemble

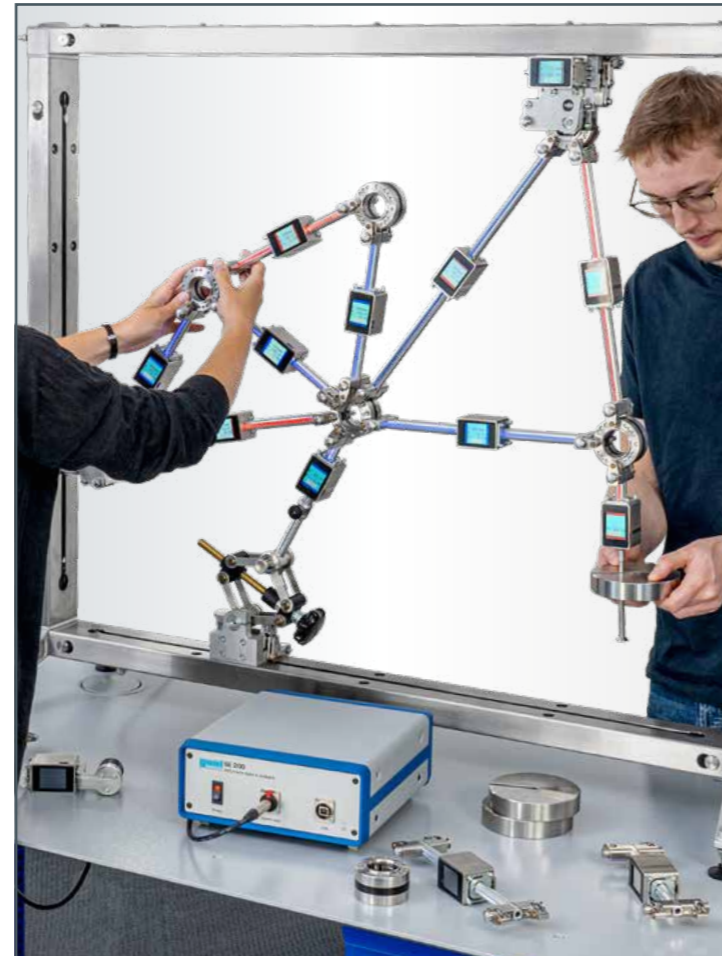

Experimental learning

- promotes self-directed learning and effective teamwork
- accessories of the series can be combined in a modular way for setup and extension of the experiments
- possibility to create your own experiments with many variations

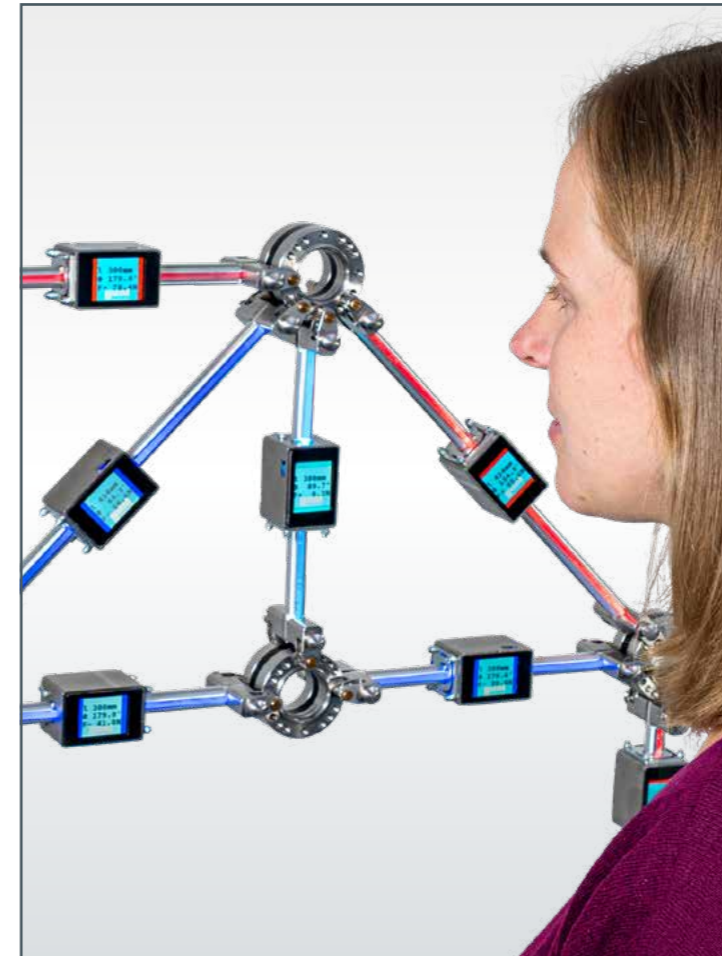

Visual comprehension

- promotes abstraction skills
- visual representation of experimental processes that are otherwise invisible and can only be understood through calculation

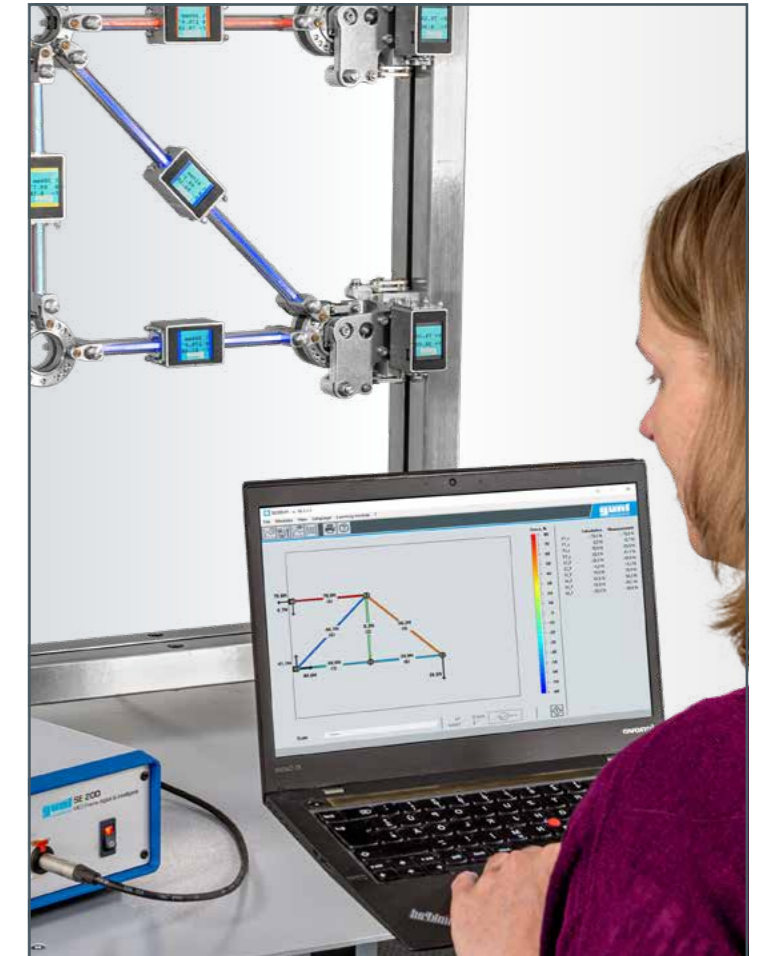





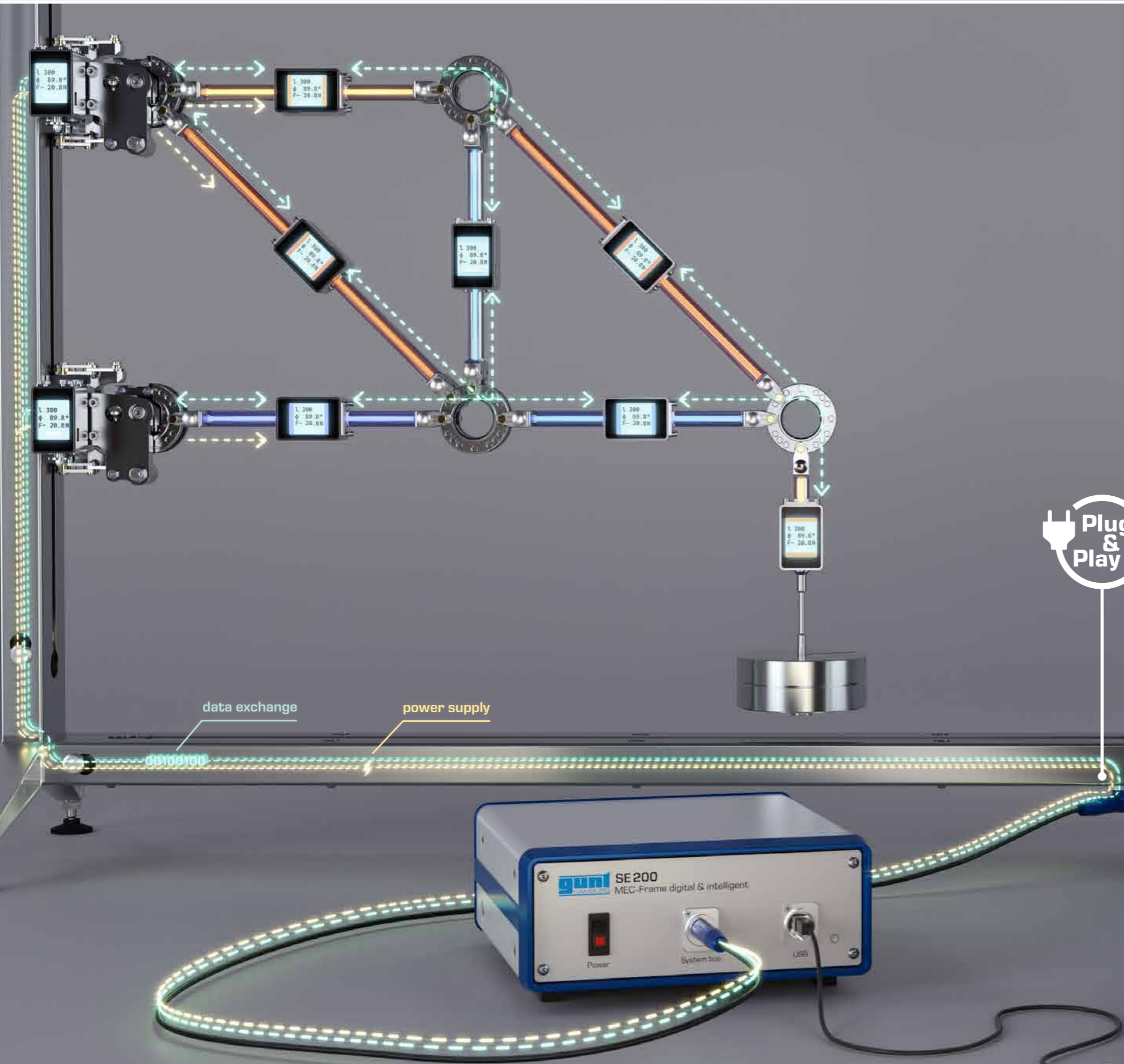

Logical thinking

- promotes the recognition of interrelationships through the transmission of topology
- analysis of measurement results and estimation of errors



Smart data flow – wireless information and power supply



-  tensile load
-  compressive load
-  neutral
-  data exchange
-  power supply

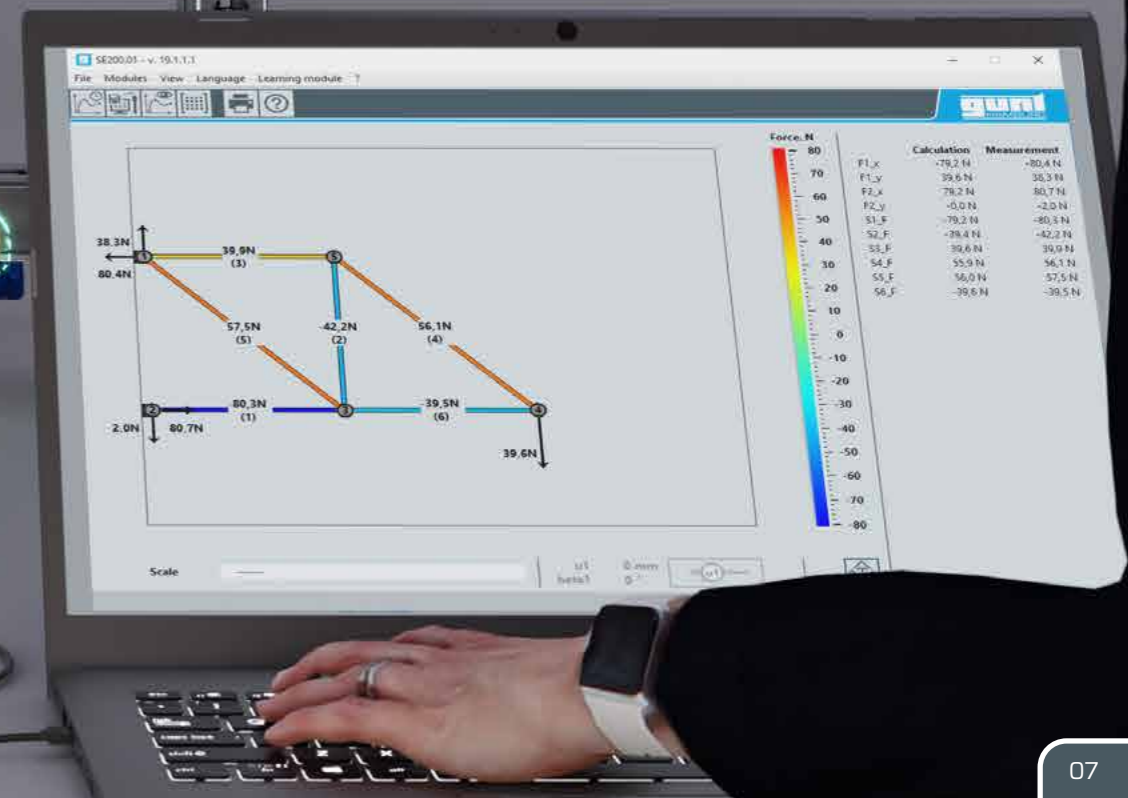

Structure of the MEC Line

Full experimental setups are created from the mounting frame and the components for experiments, setup and measurement technology. The experiments are accompanied by software for real-time visualisation, measurement data acquisition and analysis.

MEC – Frame: digital & smart

Mounting frame to hold smart, communication-enabled components with a master module for digital connection and measurement data acquisition



To SE 200

Components for experiments in statics and strength of materials as accessories

- smart, communication-enabled bars with electronic module
- bridge components and beams
- pulley blocks, etc.

All components for the experiments including GUNT software

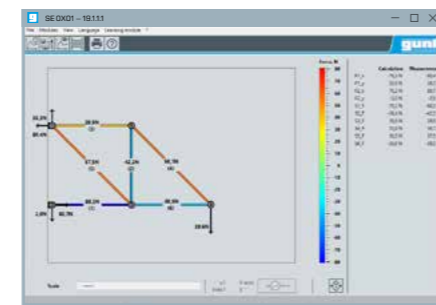
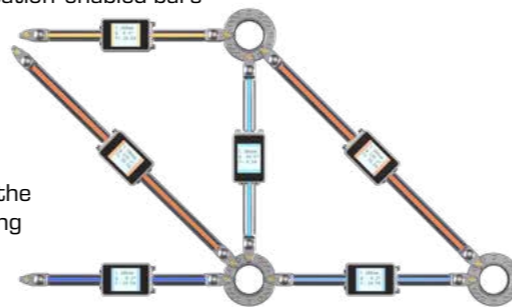

Components for the setup and measurement technology as accessories

Smart, communication-enabled loads, supports, distance measurement etc. equipped with an electronic module for data acquisition and measured value display



Access to the GUNT Science Media Center

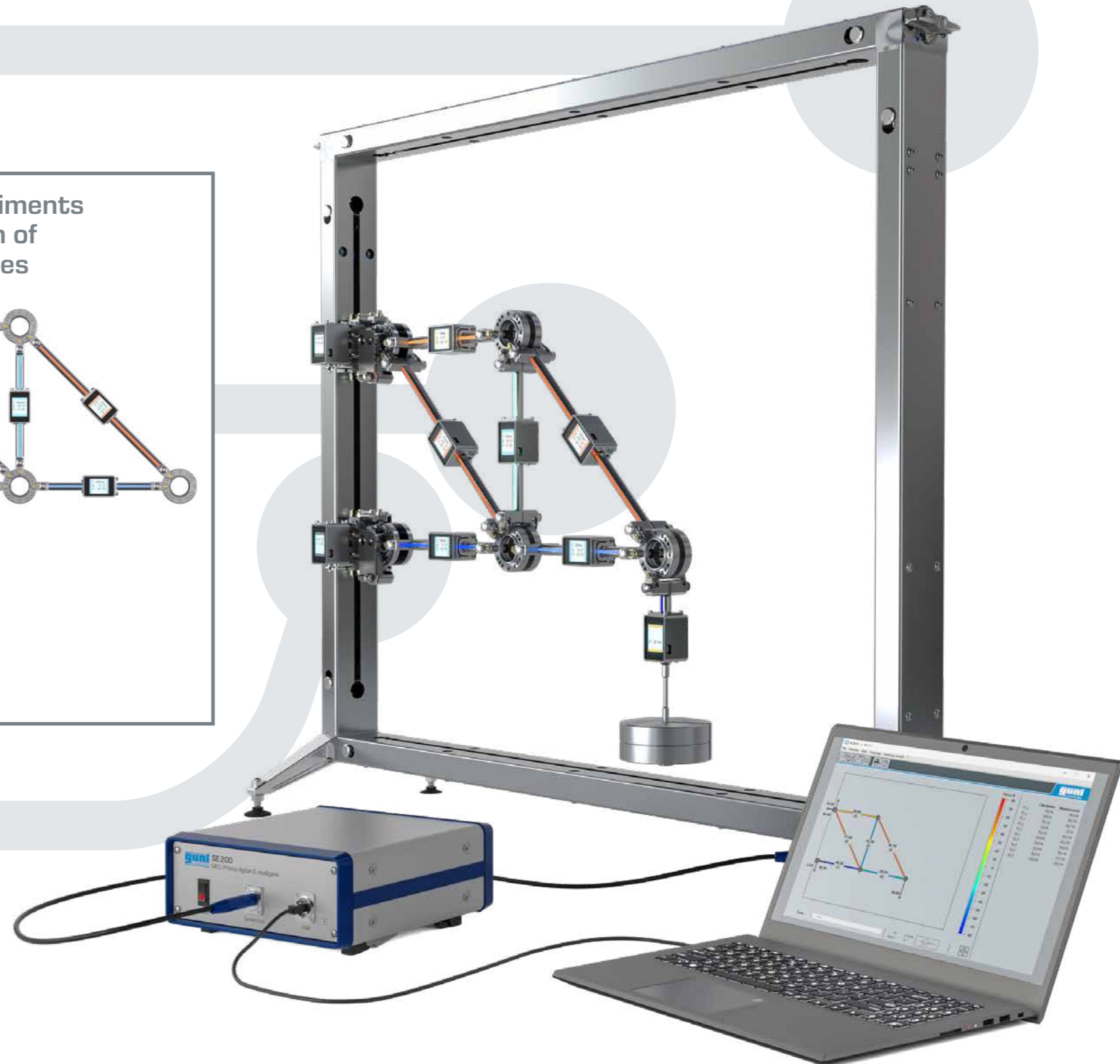

Smart, communication-enabled components for the setup and measurement technology

Components for the setup



Mounting frame

- base element for setting up versatile experiments
- click system for easy setup and reconfiguration, no tools required
- stainless steel hollow sections with integrated electrical cable
- defined snap-in points for exact topology determination and transmission

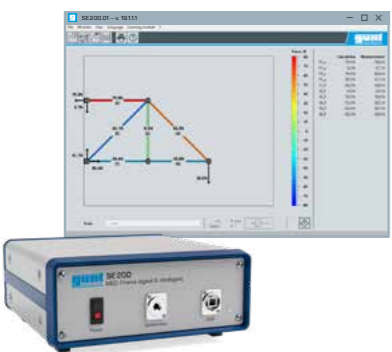

Master module and software

- master module detects all data from the electronic modules and transmits it to the GUNT software via USB
- automatic identification of the smart, communication-enabled components including position and alignment
- master module connected via Plug&Play and only 1 power BUS line

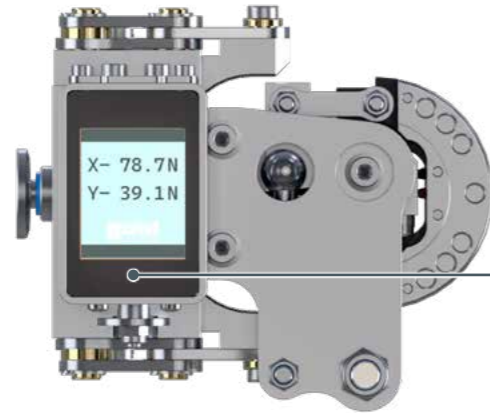

Support

- fixed support for connecting smart, communication-enabled components via click system
- horizontal or vertical installation at different positions in the mounting frame
- automatic detection of the installation position and dynamic adjustment in the GUNT software

Electronic module

- equipped with planar beam load cells for direct force measurement in x, y direction
- integrated acceleration sensor for angle measurement for correct display of the geometry



Bar

- tool-free setup and reconfiguration of various trusses without cabling
- force displayed as a measured value and as coloured illumination directly on the bar
- bars with articulated connection to node disks; loading only on compression or tension

Electronic module

- equipped with planar beam load cell for direct force measurement in the x direction
- communication in both bar directions to determine topology
- integrated acceleration sensor for angle measurement for correct display of the geometry

Components for measurement technology



Load

- generation of weight forces through concentrated load
- generation of distributed loads by combining several load elements
- **electronic module** with Gray code reader for position detection and transmission to the GUNT software

Distributed load



Vertical load

- various weights included in delivery
- visual representation of the force as coloured illumination
- **electronic module** contains Planar Beam load cell for direct force measurement; transfer of position using topology

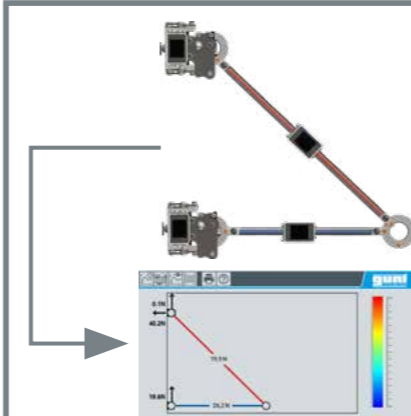

Topology

- real-time transmission of the topology to the geometry display in the GUNT software
- exact visualisation of the experiments during setup
- special algorithm for topology transmission, developed by GUNT

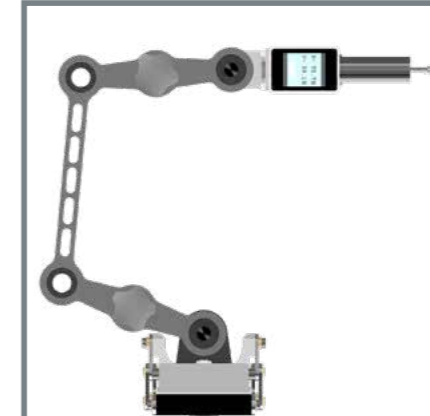

Distance measurement











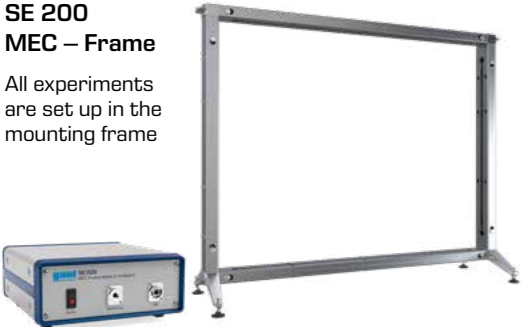



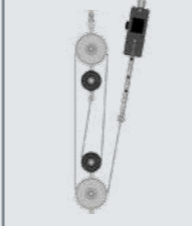

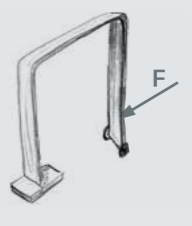

- articulated arm with long reach
- **electronic module** contains linear potentiometer for detecting paths and an acceleration sensor for detecting the measuring direction

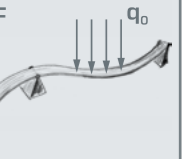

Load unit

- stepless generation of tensile and compressive forces in any direction
- visual representation of force
- **electronic module** contains Planar Beam load cell for direct force measurement and an acceleration sensor to detect the measuring direction

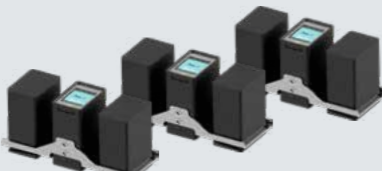
Accessories

<p>SE 200 MEC – Frame</p> <p>All experiments are set up in the mounting frame</p> 	<p>SE 200.01 Forces in trusses</p> 	<p>SE 200.02 Forces on a suspension bridge</p> 	<p>SE 200.03 Parabolic arch bridge</p> 	<p>SE 200.04 Friction on the inclined plane</p> 	<p>SE 200.05 Cable forces and pulley blocks</p> 	<p>SE 200.06 Three-hinged arch</p> 	<p>SE 200.07 Gerber beam</p> 	<p>SE 200.08 Buckling</p> 	<p>SE 200.09 Deformation of frames</p> 	<p>SE 200.10 Torsion of bars</p> 	<p>SE 200.11 Elastic line of beams</p> 
<p>SE 200.21 Support</p> 	2	2	2	-	min. 1 max. 2	2	2	-	2	-	2
<p>SE 200.22 Load unit</p> 	max. 2	-	-	-	-	-	-	1	1	-	1
<p>SE 200.23 Distance measurement</p> 	max. 1	-	2	-	-	-	-	min. 1 max. 2	min. 1 max. 2	-	min. 1 max. 2
<p>SE 200.24 Vertical load</p> 	min. 1 max. 2	-	max. 1	-	min. 1 max. 2	1	max. 1	-	1	-	max. 1
<p>SE 200.25 Load (Set of 5)</p> 	-	1	1	-	-	1	1	-	-	-	-
<p>SE 200.26 Distributed load (Set of 3)</p> 	-	max. 1	max. 1	-	-	max. 1	max. 1	-	-	-	-
<p>SE 200.27 Bar set</p> 	any quantity	-	-	-	-	-	-	-	-	-	-

SE 200.01 MEC – Forces in trusses

- smart, communication-enabled bars with electronic modules for data acquisition and measured value display
- measured values and coloured display of the force directly on the bar
- setup of various trusses without cabling
- calculated displacement of the truss can be magnified in the software
- automatic identification and assignment of the bars in the GUNT software

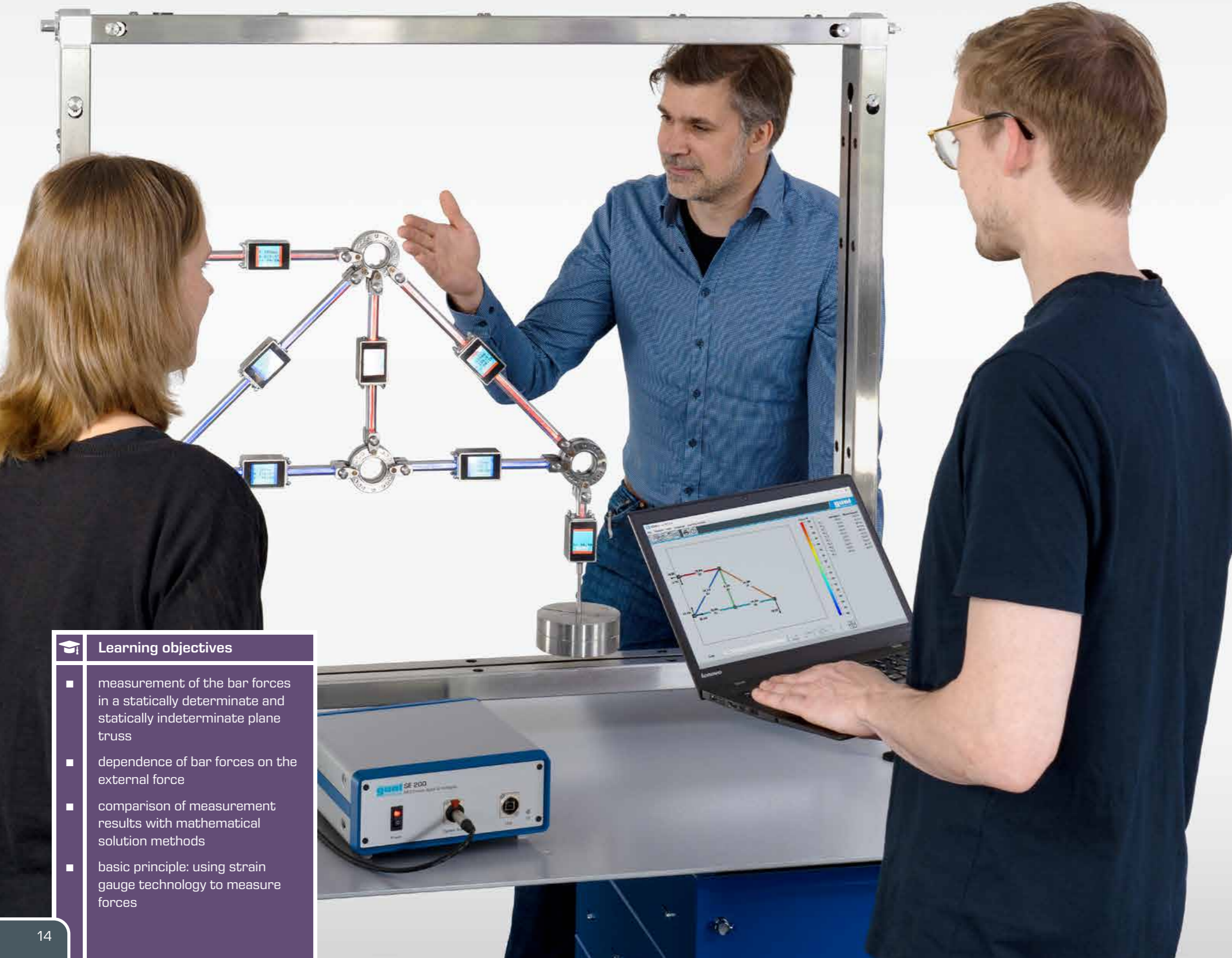

Learning objectives

- measurement of the bar forces in a statically determinate and statically indeterminate plane truss
- dependence of bar forces on the external force
- comparison of measurement results with mathematical solution methods
- basic principle: using strain gauge technology to measure forces

Exercises

- 1 Setup of any truss with at least 6 bars and 1 load
 - exact recording of the geometry with real-time transmission to the GUNT software
 - measured values displayed directly on the bar, can be hidden if required

- 2 Calculation of external forces: loading by load, reaction of the supports

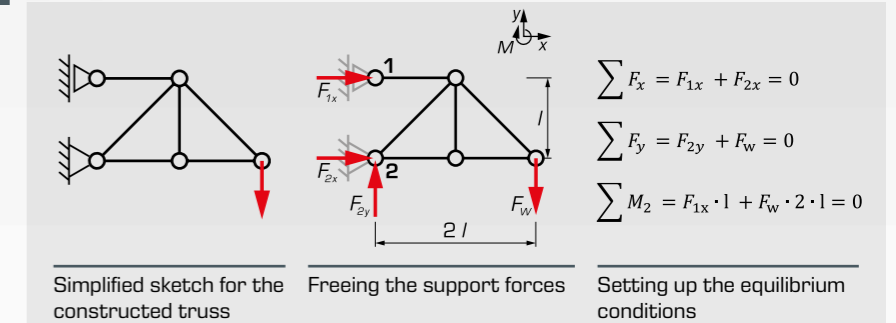

- 3 Calculation of internal forces: select and apply method of joints or Ritter's method of sections

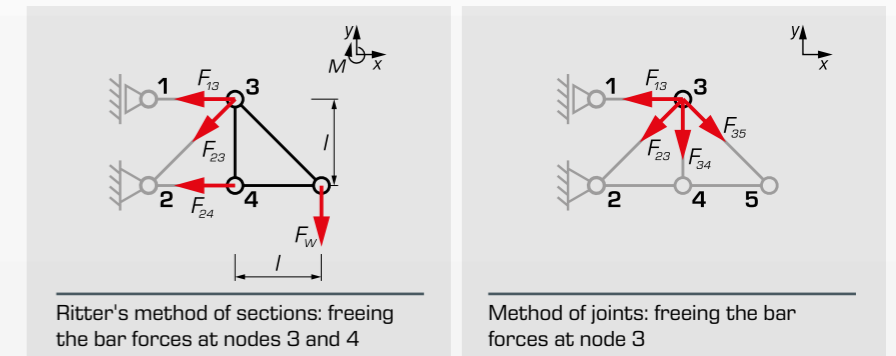

- 4 Checking the calculation: comparison of results with measured values and results in the GUNT software

Forces displayed in colour and measured values displayed in matrix form

	U in mm	F in N
u_{1x}	247,1	-70,2
u_{1y}	-70,2	19,9
u_{2x}	0	232,1
u_{2y}	0	84,2
u_{3x}	-247,1	70,2
u_{3y}	70,2	-19,9
u_{4x}	0	0
u_{4y}	0	0
u_{5x}	247,1	-70,2
u_{5y}	-70,2	19,9

SE 200.02 MEC – Forces on a suspension bridge

Exercises

- 1** Setup of a suspension bridge with rigid roadway and no additional loading
 - exact recording of the geometry with real-time transmission to the GUNT software
 - measured values displayed directly on the supports, can be hidden if required software

- 2** Calculation of external and internal forces without additional loading
 - setup of a suspension bridge together with smart, communication-enabled accessories
 - experiments with rigid or flexible roadway
 - automatic identification and assignment of the loads in the GUNT software

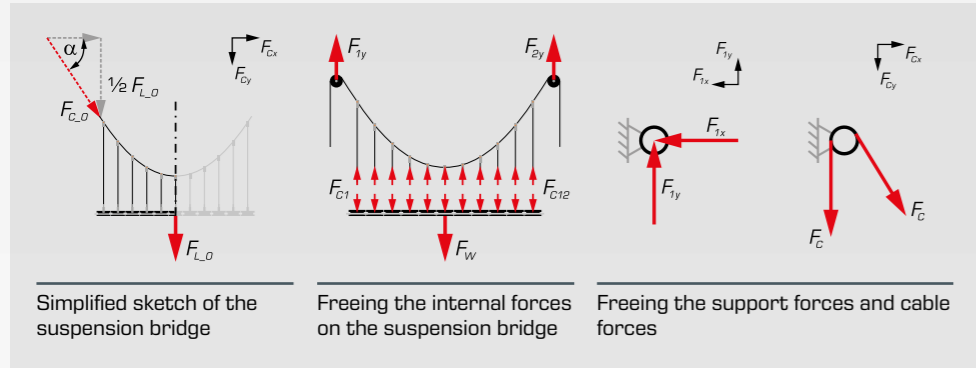

- 3** Calculation of external and internal forces with additional loading by single load, distributed load or moving load
 - loading of a suspension bridge together with smart, communication-enabled accessories
 - experiments with rigid or flexible roadway
 - automatic identification and assignment of the loads in the GUNT software

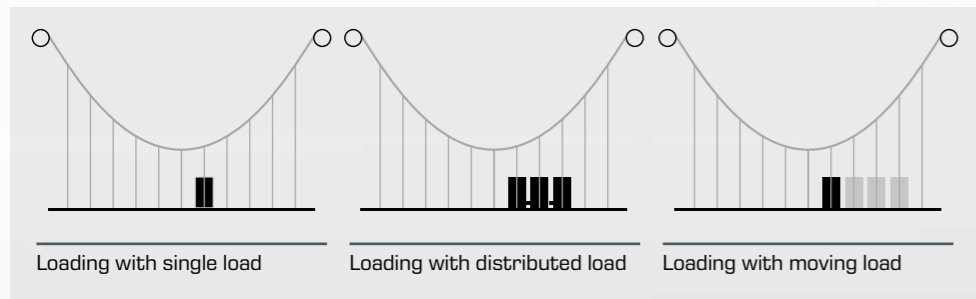

- 4** Checking the calculation: comparison of results with measured values at load/supports and the results from the GUNT software
 - loading of a suspension bridge together with smart, communication-enabled accessories
 - experiments with rigid or flexible roadway
 - automatic identification and assignment of the loads in the GUNT software

	F _{1x,1}	F _{1y,1}	F _{1x,2}	F _{1y,2}	F _{2x,1}	F _{2y,1}	F _{2x,2}	F _{2y,2}
N	N	N	N	N	N	N	N	N
3	10.0	42.3	22.9	10.5	42.5	22.4		
4	12.5	30.9	27.0	11.7	42.0	22.9		
5	12.6	30.1	26.6	11.7	43.5	23.3		
6	12.3	28.3	26.2	11.7	44.9	23.7		
7	12.3	26.7	25.9	11.6	45.3	24.1		
8	12.3	26.7	25.9	11.6	46.2	24.6		
9	12.3	26.7	25.9	11.6	47.1	25.0		
10	12.3	26.7	25.9	11.5	48.1	25.4		
11	12.3	26.7	25.9	11.5	49.0	25.9		
12	11.9	24.2	23.7	11.4	49.9	26.2		
13	11.8	22.4	23.3	11.3	50.8	26.7		
14	11.8	20.6	22.9	11.3	51.7	27.1		

Recording the measured values when loading with moving load



Learning objectives

- measurement of suspension cables forces on
 - ▶ unloaded suspension bridge
 - ▶ loaded suspension bridge
- measurement of the support forces as a function of the loading on the suspension bridge
- behaviour of a suspension bridge with rigid or flexible roadway
- investigation of distributed loads
- effect of a moving load

SE 200.05 MEC – Cable forces and pulley blocks

Exercises

- Setup of a four-cable pulley block with at least one loose and one fixed pulley
 - exact recording of the geometry with real-time transmission to the GUNT software
 - measured values displayed directly on the suspension cables, can be hidden if required

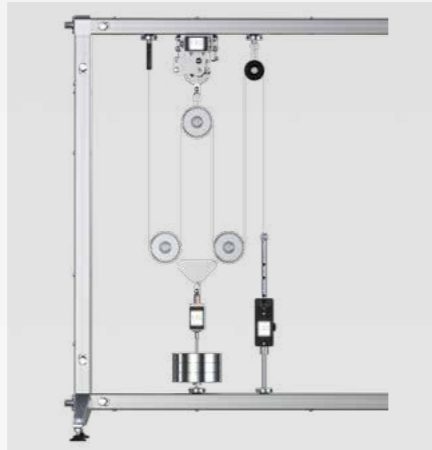

- Calculation of cable forces and support forces

Equilibrium of forces:
 $\sum F_y = 0 = 4 \cdot F_C - F_L$
 Cable force:
 $F_C = \frac{F_L}{4}$
 Setting the equilibrium condition and calculation of cable force

Freeing the load to determine the cable forces

Equilibrium of forces:
 $\sum F_y = 0 = F_B - 2 \cdot F_C$
 Support force:
 $F_B = \frac{F_C}{2}$
 Setting the equilibrium condition and calculation of support force

Freeing the support forces

- Checking the calculation: comparison of results with the measured values on suspension cable/supports and the results from the GUNT software

F1y	30 N
F1x	15 N
alpha1	90 °
L1	0 mm
F1g	60 N
F2y	75 N
F2x	15 N
alpha2	100 °
L2	0 mm
F2g	60 N

- smart, communication-enabled suspension cables with electronic modules for data acquisition and measured value display
- investigate 2 different pulley blocks at the same time
- 2 setup variants possible per pulley block
- automatic identification and assignment of the pulley blocks in the GUNT software

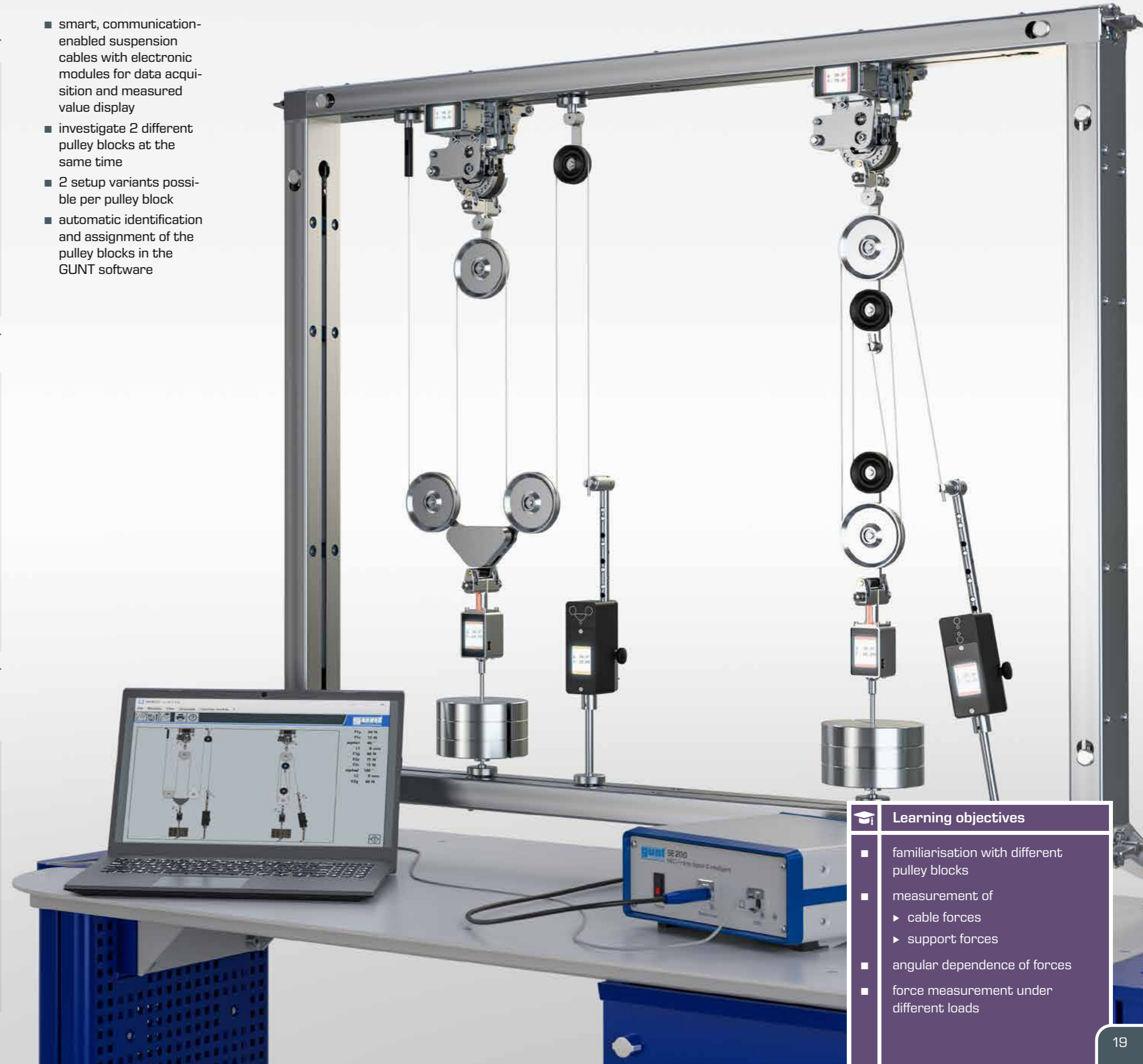

Learning objectives

- familiarisation with different pulley blocks
- measurement of
 - cable forces
 - support forces
- angular dependence of forces
- force measurement under different loads

GUNT Science Media Center

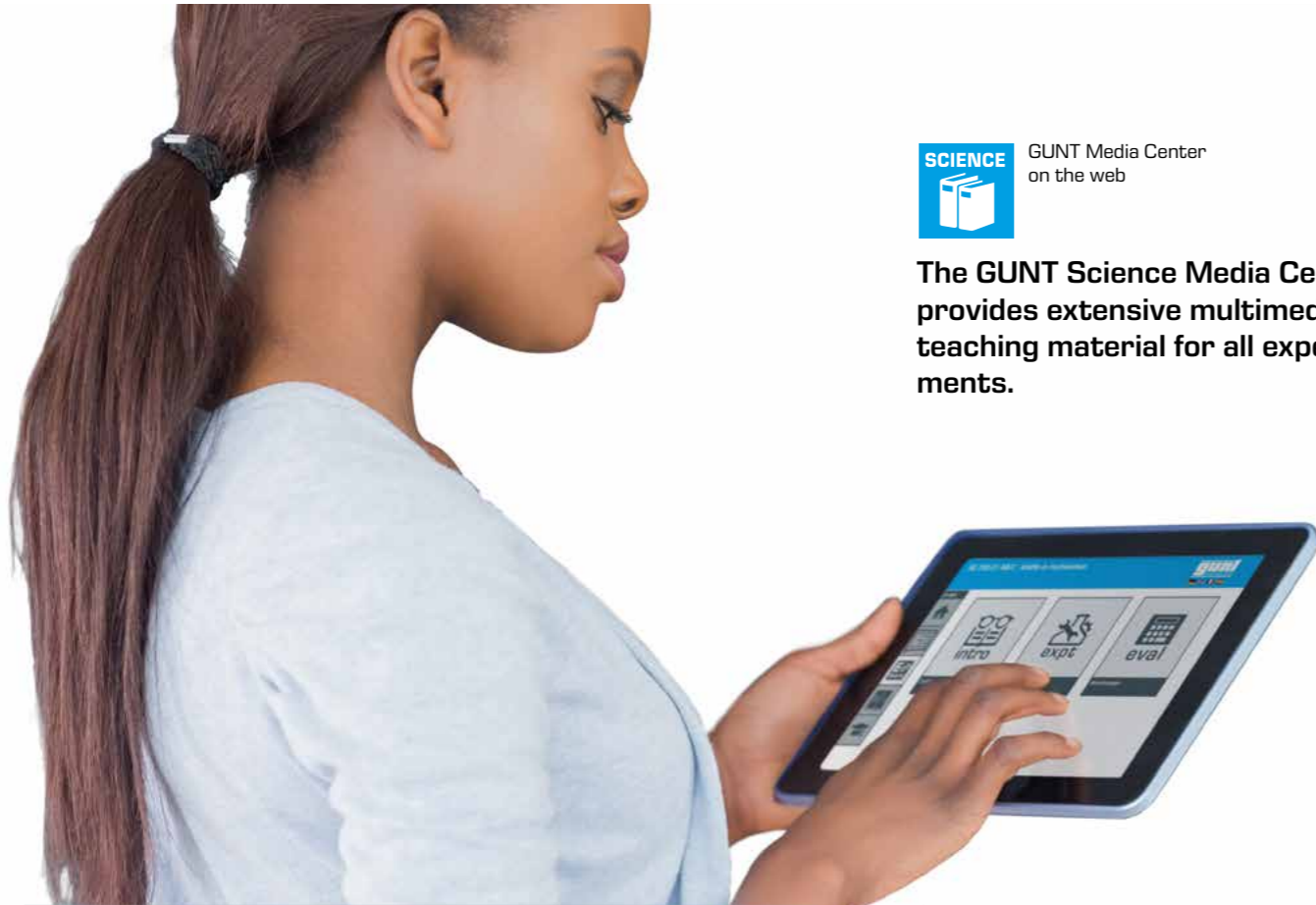

The GUNT Science Media Center provides extensive multimedia teaching material for all experiments.

Customers can access files and product information for selected products at any time and from any place. In addition to digital worksheets and the manual, access to E-Learning is also included.



The E-Learning course

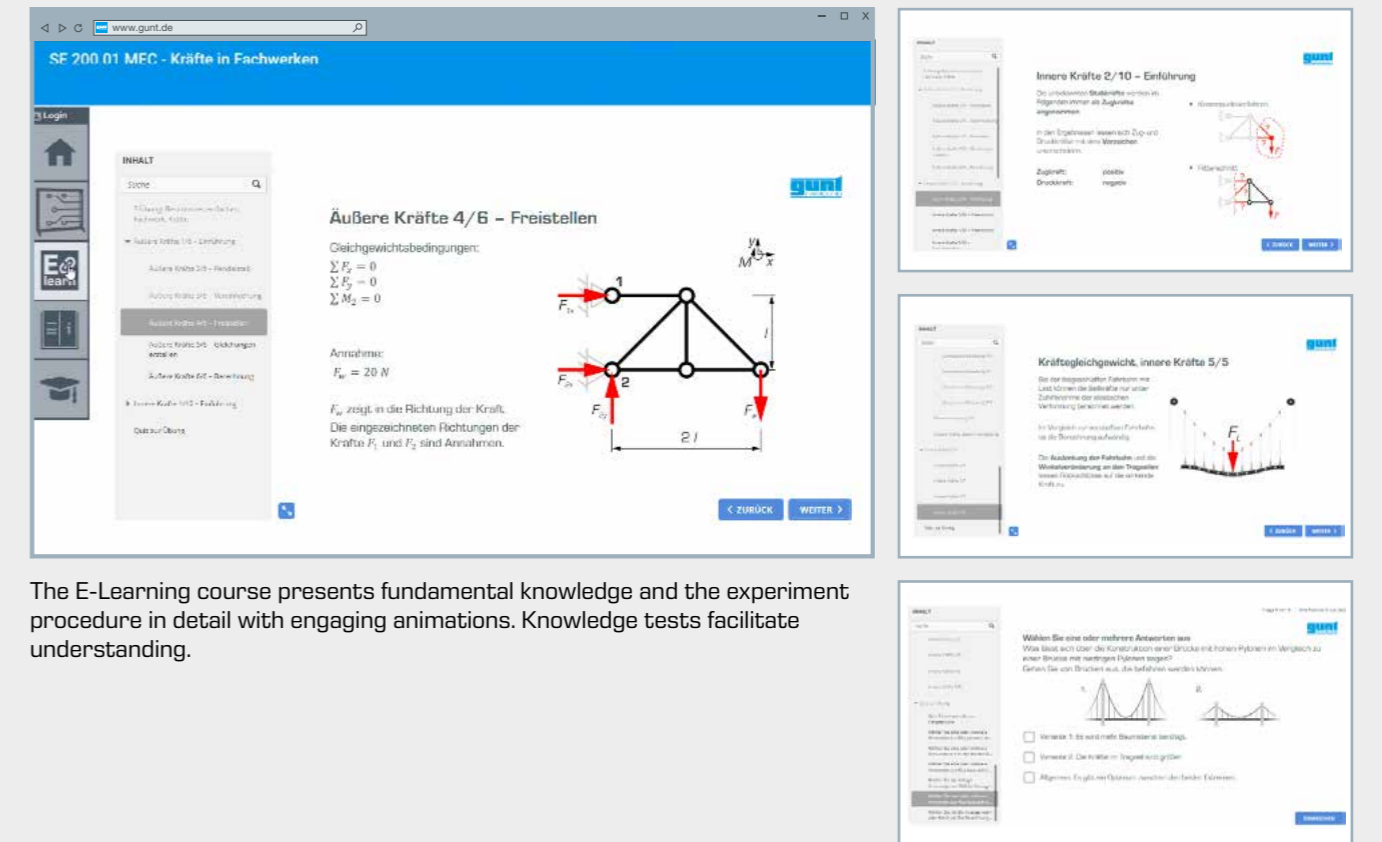

The E-Learning course presents fundamental knowledge and the experiment procedure in detail with engaging animations. Knowledge tests facilitate understanding.

Digital worksheets

Digital worksheets are available for the individual experiments. Access to solutions is password protected.

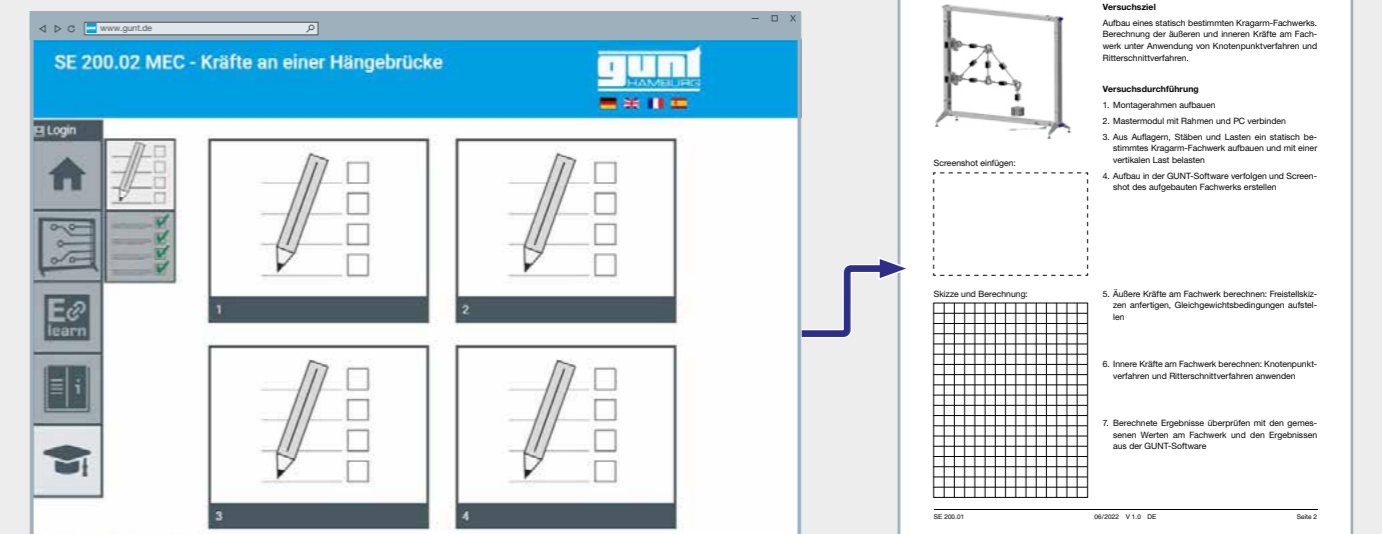

Our product programme

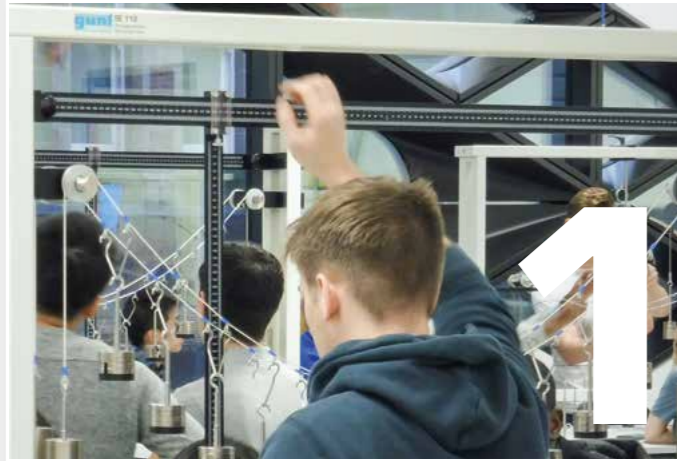

1

**Engineering mechanics
and engineering design**



2

Mechatronics



3

Thermal engineering



4

Fluid mechanics



5

Process engineering



6

Energy & Environment



**Equipment for
engineering education**

Entire programme



New catalogue
**Entire
programme**

- planning and consulting
- technical service
- commissioning and training



Contact

G.U.N.T. Gerätebau GmbH
Hanskampring 15-17
22885 Barsbüttel
Germany

+49 40 67 08 54 - 0
sales@gunt.de
www.gunt.de



Visit our website
www.gunt.de

