



## **GUNT experimental flumes**

- open-channel flow at the laboratory scale
- open channels with a rectangular cross-section
- investigation of control structures, changes in cross-section, discharge measurement and waves

## Table of contents

Hydraulic engineering is a crucial part of engineering. How do we achieve the necessary river depth for ships? How does open-channel flow change during flooding? How far upstream do measures such as control structures have an effect? How can the discharge at barrages be calculated?

In order to understand answers to these questions and develop possible solutions, experimental flumes are used in teaching and research. This demonstrates and investigates the phenomena of open-channel flow on a laboratory scale. For example, control structures for flow regulation and various methods of flow measurement are demonstrated.

GUNT experimental flumes with their extensive accessories offer a wide range of experiments and demonstrations on the topics of open channels, flowing waters, hydraulic engineering and coastal protection.

### **GUNT develops your solution when the standard does not lead to the goal.**

- analysis of your needs with the help of our decades of experience and in-depth know-how
- together with you: development of a high-quality and individual solution
- internal examination of the technical feasibility by GUNT
- together with you: evaluation and planning of the implementation

### **Customised experimental flumes to suit your application.**

To references:



About the flumes:



<b>Overview of GUNT experimental flumes</b>	4
<b>Technical details for GUNT experimental flumes</b>	6
<b>Automated operation and data acquisition</b>	10
<b>Accessories for experimental flumes</b>	12
<b>Open-channel flow in the lab</b>	28
<b>Instrumentation</b>	30



# Overview of GUNT experimental flumes

GUNT experimental flumes and their accessories open up a wide range of experiments and demonstrations on the topics of open-channel flow, running waters, hydraulic engineering and coastal protection. They form the expandable foundation for custom investigations and research work. Experimental flumes from GUNT have been successfully put to use around the world for many years.

For each of the experimental flumes, there is a variety of models for discharge control, such as weirs, sills, stilling basins, as well as wave generators, beach elements and bridge piers. Technical solutions for sediment feed and removal are also available. In addition, we can also provide specially adapted instrumentation such as water level gauges, pitotstatic tubes, tube manometers and velocity meters.

### Design features

- rigidity against deformation
- side walls made of tempered glass
- all surfaces in contact with water are made of corrosion-resistant materials
- low-turbulence flow at the entrance to the experimental section

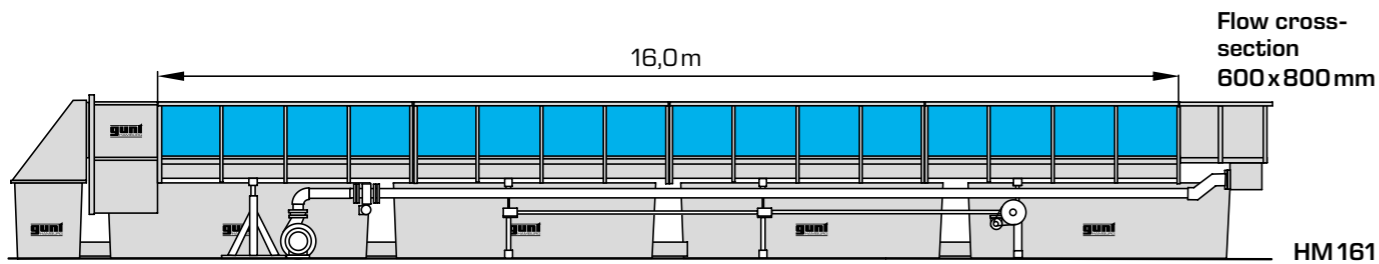
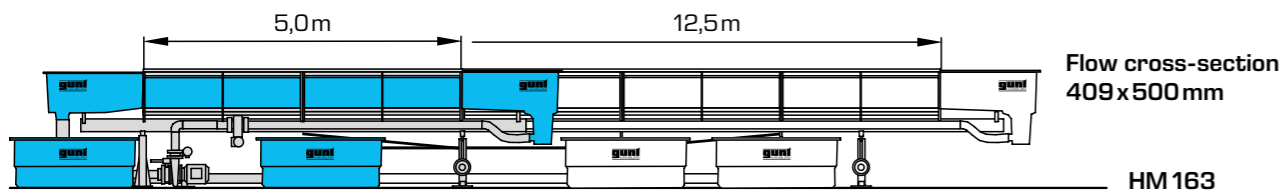
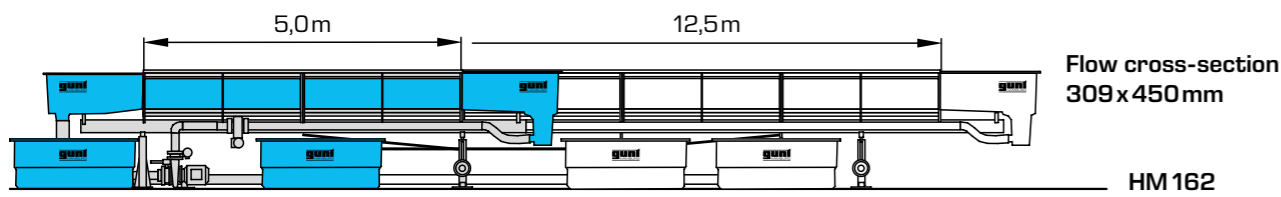
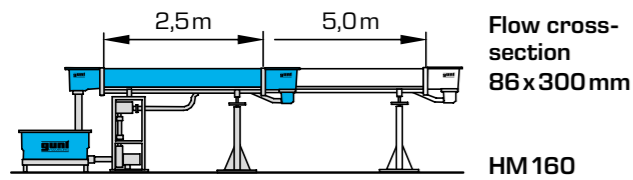

GUNT provides four experimental flumes with different cross-sections, depending on the purpose of use and the local conditions:

- HM160 (86x300 mm)
- HM162 (309x450 mm)
- HM163 (409x500 mm)
- HM161 (600x800 mm)

The experimental flumes have different lengths of experimental section to choose from:

- HM160 with experimental sections of 2,5m or 5m
- HM162 and HM163 with experimental sections of 5m, 7,5m, 10m or 12,5m
- HM161 with an experimental section of 16m

As a result, the length of the experimental section can be adjusted to the individual requirements of the laboratory.



The HM160 flume is perfectly suited as an introduction to the topic of open-channel flow and the demonstration of many of the basic principles. This flume is compact and requires little space.

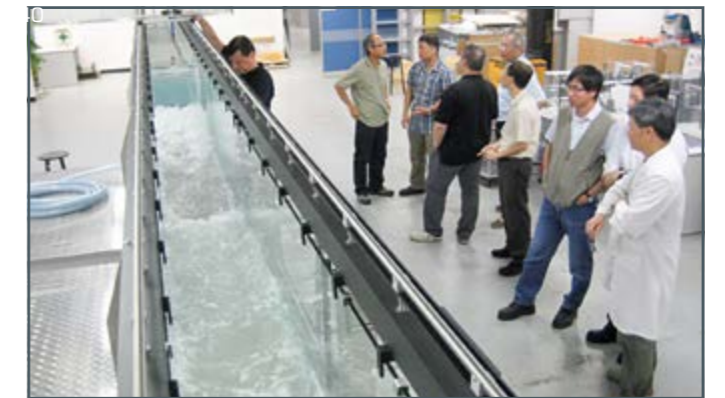

The HM162 and HM163 experimental flumes can be supplied in four different lengths. The "short" experimental flume, with an experimental section of 5m, can easily be set up even in smaller laboratories. As the length of the experimental section increases, the observation section upstream and downstream of obstacles increases.



The largest GUNT experimental flume HM161 – with a cross-section of 600x800mm and a 16m long experimental section – offers a large number of possibilities for your own research projects.



# Technical details for GUNT experimental flumes

## The closed water circuit

### The water circuit

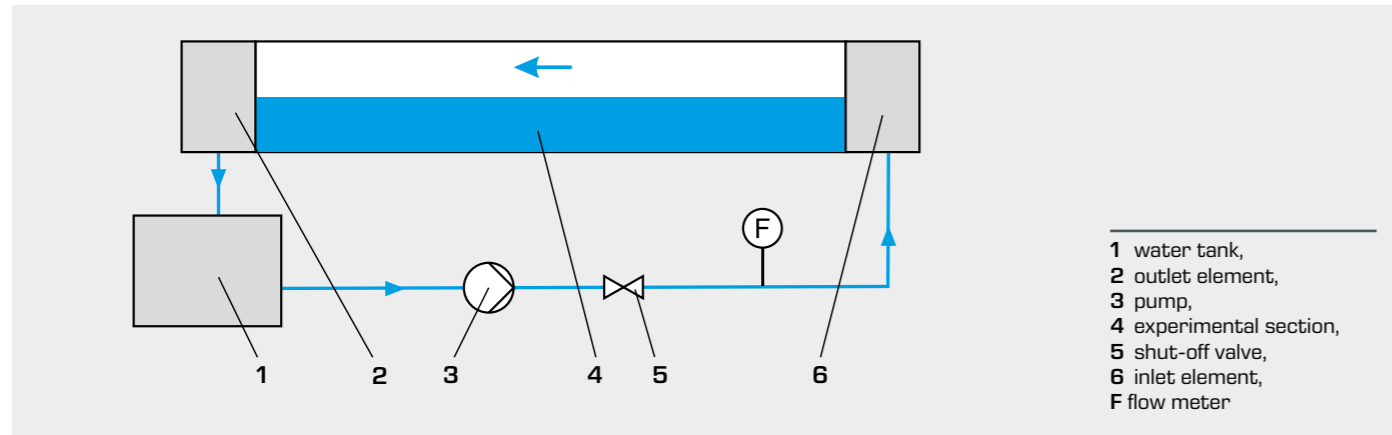

All experimental flumes can be operated independently of the laboratory water supply and have a closed water circuit with water tanks, pump and flow meter. To protect against over-

filling of the experimental section, level switches turn off the pump when the maximum level in the inlet or outlet element is exceeded.

### The pump

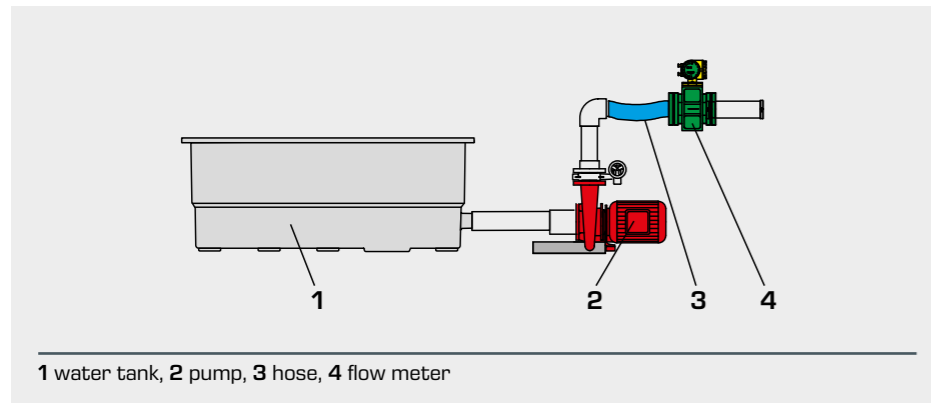

The centrifugal pump is separated from the experimental section in the experimental flumes HM 162, HM 163 and HM 161 and is mounted on its own foundation. It is connected to the piping to the inlet element via a hose. This ensures that there is no transmission of vibrations between the experimental section and the pump. In the small experimental flume HM 160 the vibrations that occur are negligible, so the pump is integrated in one of the experimental flume's supports.



Pump (HM 162) with shut-off valve with manual actuation in the delivery side for adjusting the flow rate (above the pump). The pump's delivery line also contains the hose and the electromagnetic flow meter. The shut-off valve is only needed for wave experiments.

### Methods for adjusting the flow rate in the inlet to the experimental section

All experimental flumes allow adjusting the flow rate. The speed of the pump used in HM 161, HM 162 and HM 163 is infinitely adjustable by using a frequency converter until the desired flow rate is achieved. In HM 160, a valve is used to adjust the flow

rate. The flow rate in HM 160 is measured by a rotameter, while HM 161, HM 162 and HM 163 are both equipped with an electromagnetic flow meter.

### The inlet element

In all experimental flumes, the inlet element is designed for optimum flow so that the flow is less turbulent as it enters the experimental section.

The water enters from below through a flow straightener. A damping plate calms the water further. The damping plate floats on the water and is mounted on a guide.

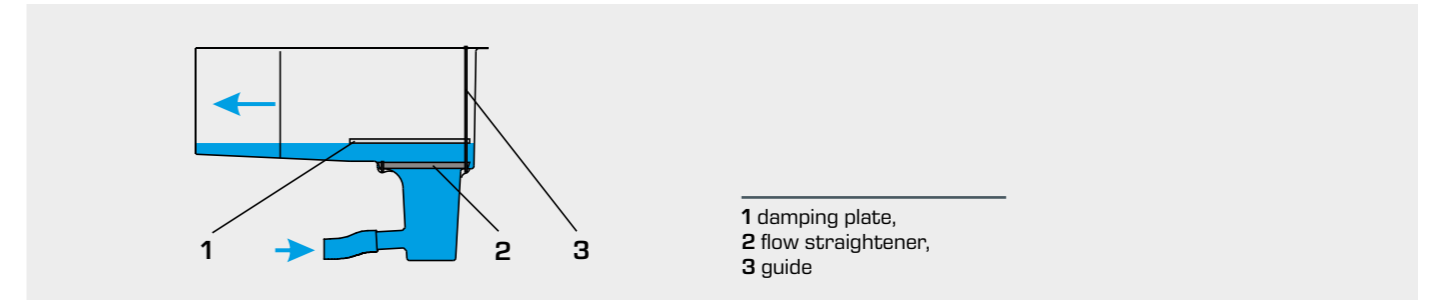

### The outlet element

The outlet element of all experimental flumes contains a plate weir. The plate weir included in HM 160 consists of six elements that can be removed, so that six damming heights are available to choose from. If all elements are removed, it corresponds to

free discharge without a weir. The plate weir included in HM 161, HM 162 and HM 163 is mounted to rotate around a fixed point and can thus be lowered completely. As such, any desired top water level can be set (see illustrations).

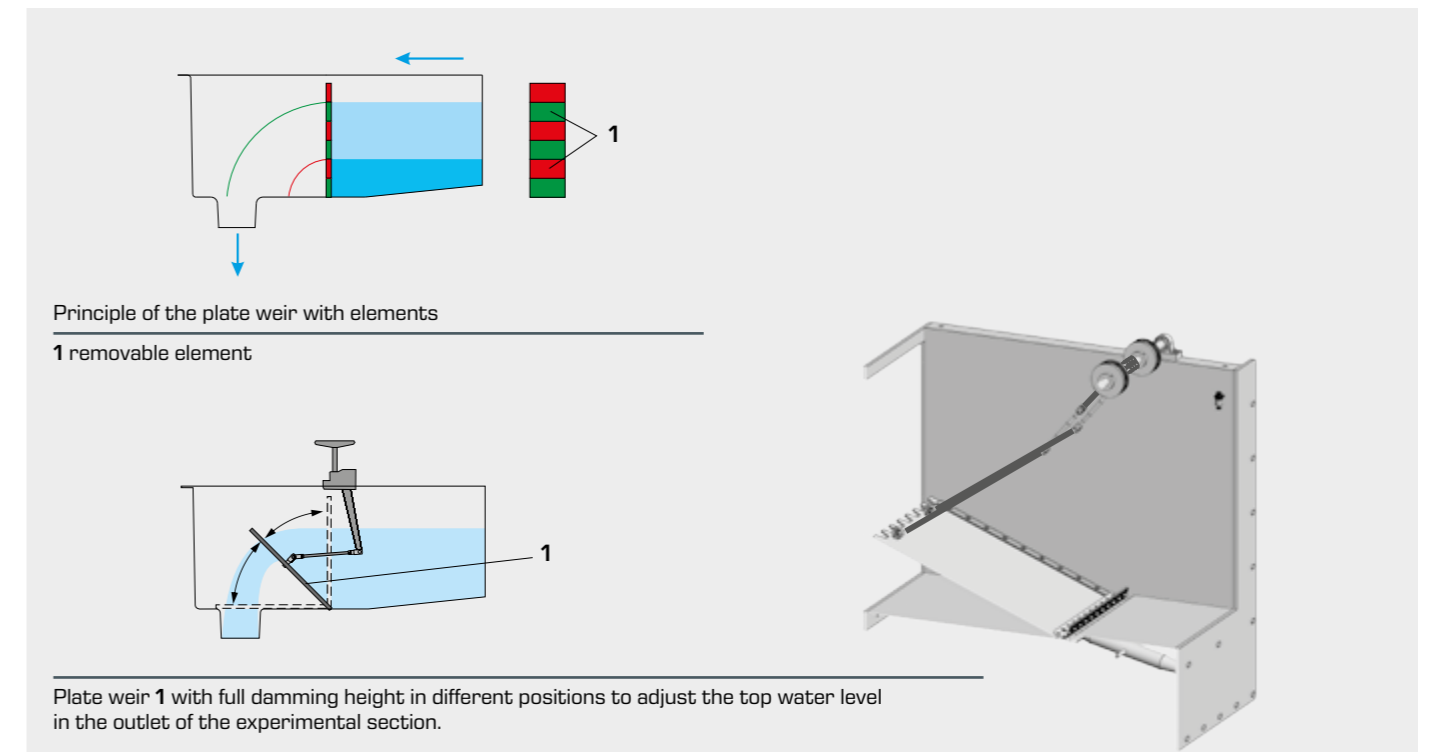



# Technical details for GUNT experimental flumes

## Structural features

### Rigidity against deformation

The experimental section of HM162 and HM163 is available in several lengths. The components used are essentially the same (modular design). In order to realise different lengths with the modular design, while maintaining inclination adjustment, the experimental flume is supported by an auxiliary carrier with two supports. In the version with long experimental section, the inevitable deformations are absorbed by the supports. The individual adjustability of the elements enables precise alignment of the experimental section.

The elements of the self-supporting experimental section in HM161 are mounted on four supports, so that there is only ever a minimal deformation.

In HM160 the stresses that occur in comparison to HM162 are small, so that doubling the length of the experimental section does not pose a problem for the rigidity of the self-supporting experimental flume with two supports.

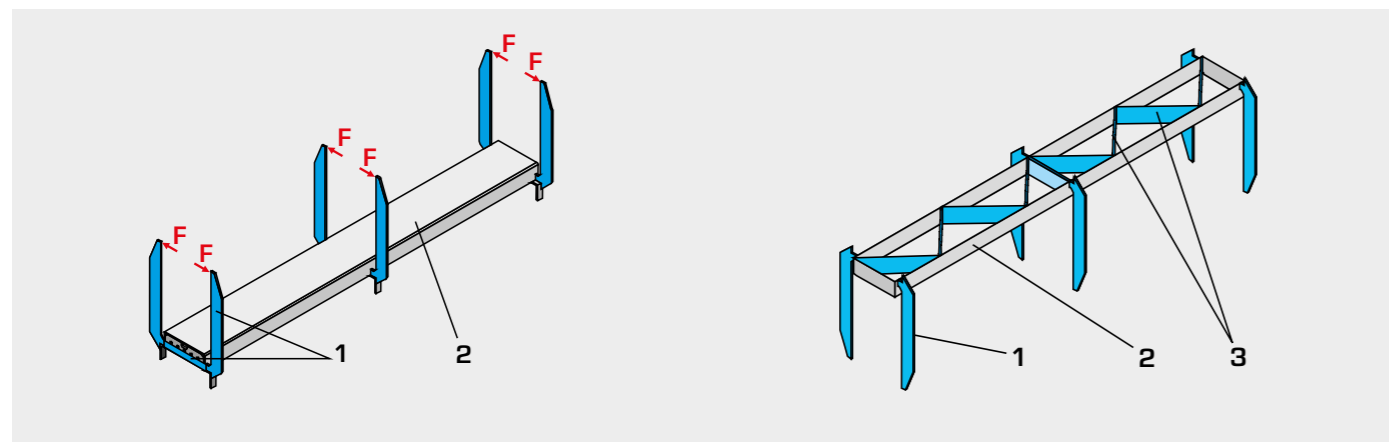
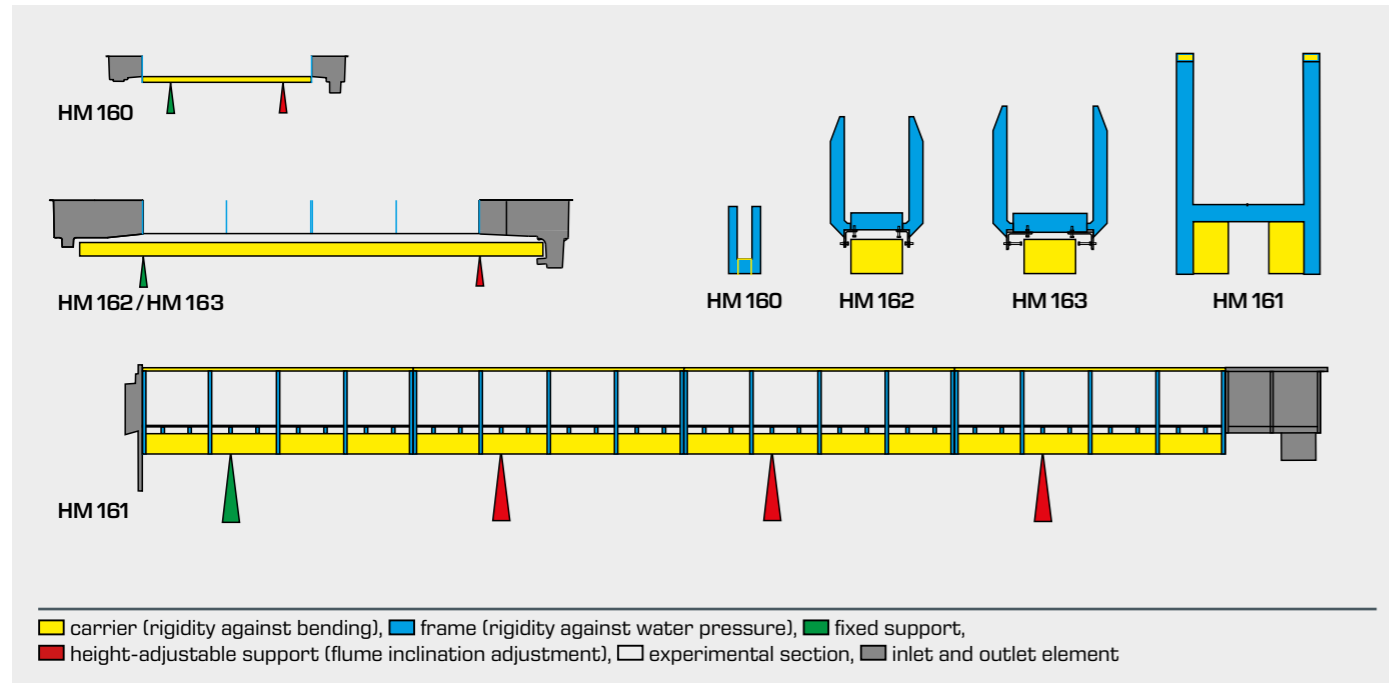

The rigidity of the elements of the experimental section against water pressure is ensured by the welded frame. The frames support the glass side walls.

Bottom element of an element of the HM162/HM163 experimental section, reinforced with diagonal ribs to increase stiffness against bending and torsion.

1 welded frame, 2 bottom element of an element of the experimental section, 3 diagonal rib, F water pressure force

### Inclination adjustment

All experimental flumes can be inclined, which means that the slope is adjustable. The current slope can be read directly on a scale (HM160, HM162, HM163) or a touch screen (HM162, HM163, HM161).

Inclination adjustment in HM160 is manual and electrical in HM161.

In HM162 and HM163 the inclination can be adjusted either manually or electrically. With an experimental section above 7,5m we recommend electrical inclination adjustment HM162.57.

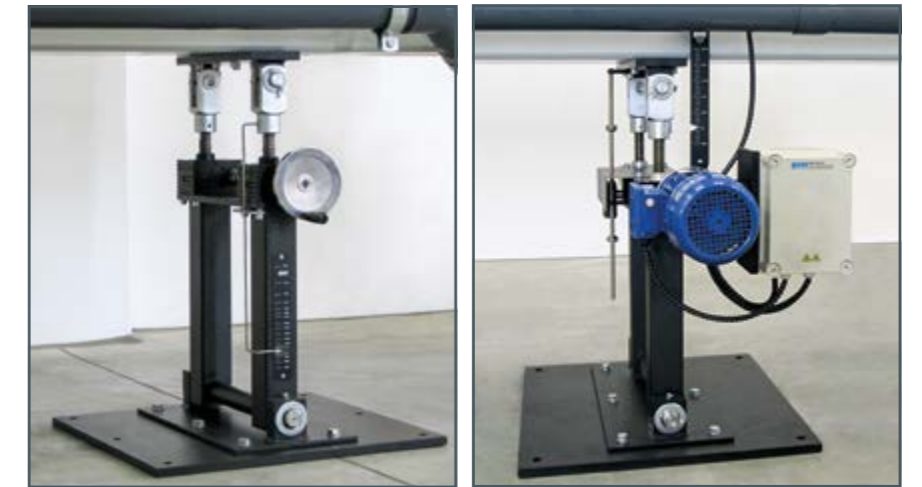

Inclination adjustment in HM162 and HM163: **left** manual, **right** electrical inclination adjustment HM162.57

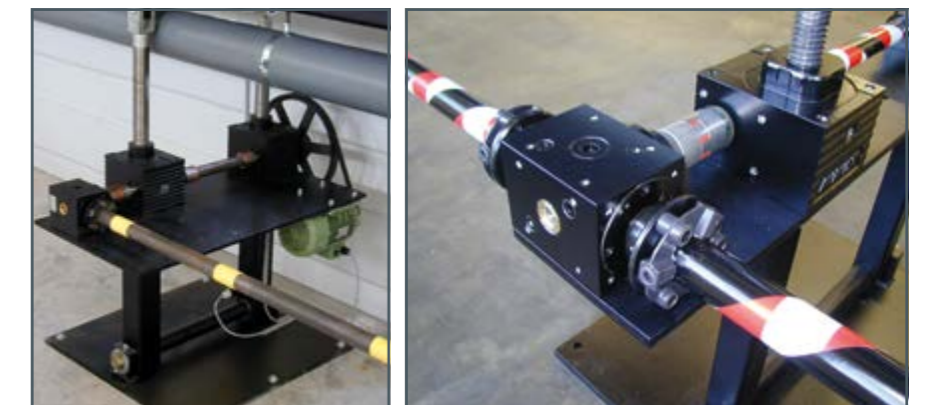

Electrical inclination adjustment in HM161

Manual inclination adjustment in HM160

### Materials used

In all experimental flumes, the bottom of the experimental section is made of stainless steel. Tempered glass is used for the side walls of the experimental section. It is scratch resistant, does not age and does not deform. The water tank, inlet and outlet elements are made of corrosion-resistant GRP (glass

reinforced plastic) or steel. The piping is PVC. The models used in the experimental flumes consist of aluminium, stainless steel, PVC or Plexiglas.

# Automated operation and data acquisition for HM 162 / HM 163 and HM 161

The experimental flumes HM 162, HM 163 and HM 161 are controlled by a PLC via touch screen. PLC-supported accessories are automatically identified and displayed. By means of an integrated router, these two experimental flumes can alternatively

be operated via end device. The user interface can also be displayed on other end devices (screen mirroring). Via the PLC, the measured values can be stored internally.

## Screen mirroring



- mirroring of the user interface on other end devices: PC, tablet, smartphone
- selection of different user levels on the end device, for tracking experiments or for control and operation
- transmitting stored measured values from the experimental unit to end devices



## GUNT software

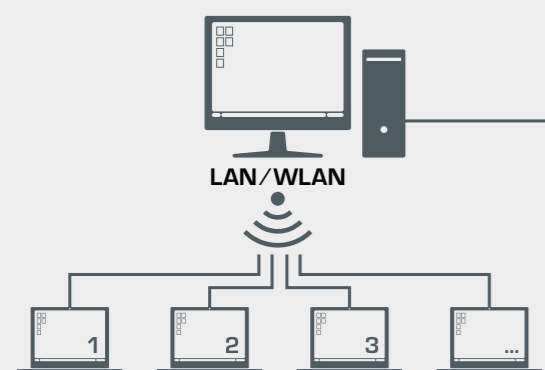

- connection of any number of end devices (Windows-based) via the customer's own network
- individually record, graphically display and evaluate measured values from pressure measurement on each end device

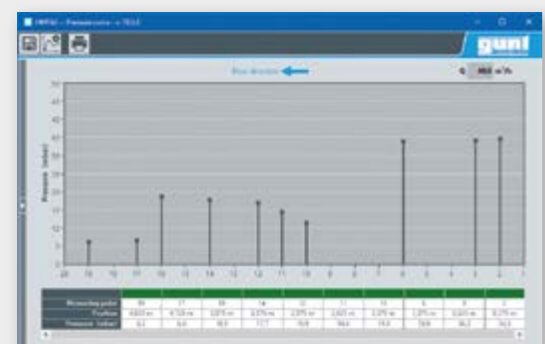

Curve of the pressure heads along the experimental section

HM 161 is equipped with two freely positionable touch panels. They display measured values and operating states and enable system operation.

At the same time, the measured values can be transmitted directly to a 32" monitor for distant reading and to a PC via LAN where they can be analysed with the software.



For experiment observation in remote learning, the use of a camera is necessary.

## PLC-supported accessories

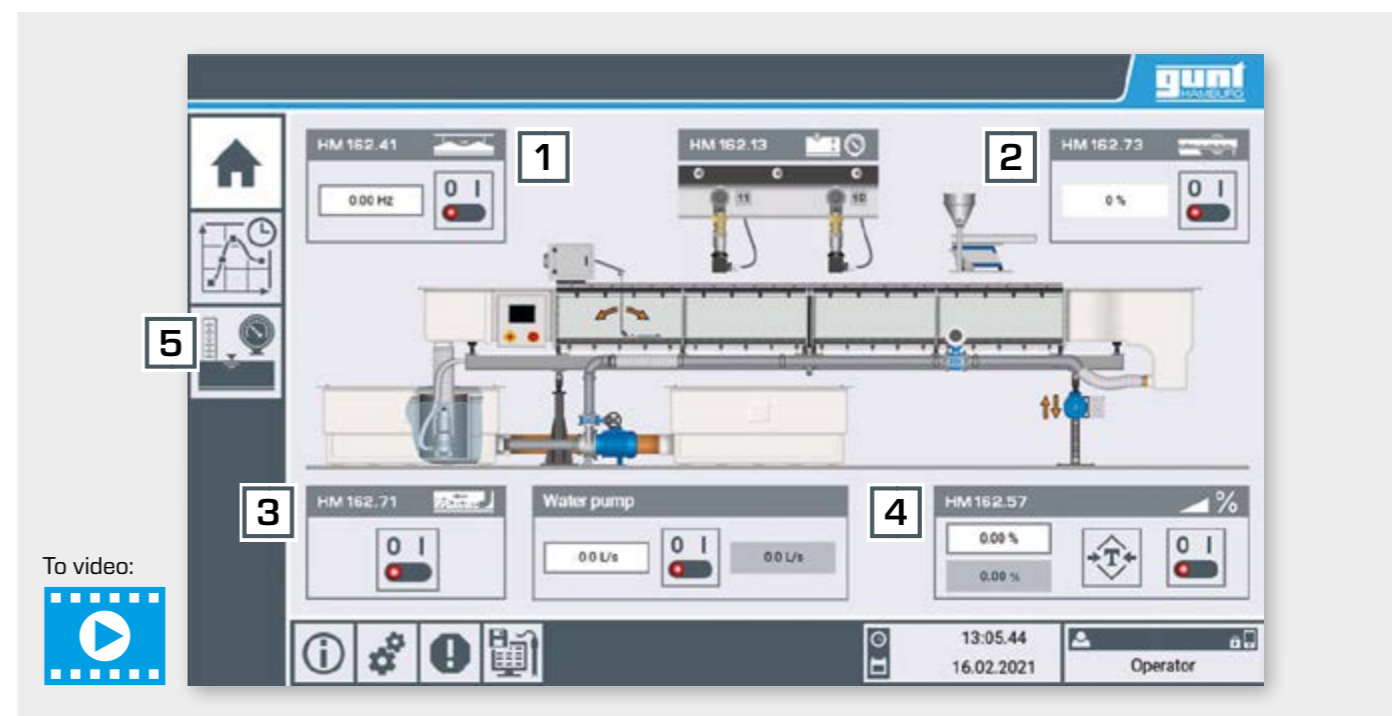

### 1 Wave generator HM 162.41 / HM 163.41 / HM 161.41

With the wave generator surface waves are generated by a paddle that swings back and forth. Flow rate, inclination adjustment and frequency of the displacement plate are set and displayed directly on the experimental flume using the touchscreen.

### 2 Sediment feeder HM 162.73 / HM 163.73 / HM 161.73

The feeder is operated and the vibration intensity is set via the touch screen of the PLC.

### 5 Electronic pressure measurement HM 162.13 / HM 161.13

With the electronic pressure measurement, the discharge depth along the experimental section in HM 162, HM 163 and HM 161 can be recorded with pressure sensors and displayed in the form of the pressure height in the GUNT software. Depending on the experiment, up to ten selected measuring points can be connected along the experimental section. Additionally, the flow rate is recorded and displayed on the touch screen of the PLC.

A second measuring amplifier HM 162.13 / HM 161.13 can be used simultaneously to display the pressure heads of 20 measuring points of the experimental section.

### 3 Closed sediment circuit HM 162.71 / HM 163.71 / HM 161.71

The sediment pump is operated via the touch screen of the PLC.

### 4 Electrical inclination adjustment HM 162.57

The electrical inclination adjustment is operated via the touch screen of the PLC of HM 162 / HM 163. The HM 161 experimental flume has motorised inclination adjustment, which is also operated via touchscreen. HM 162.57 is used with the experimental flumes HM 162 and HM 163.



HM 162.13 is used with the experimental flumes HM 162 / HM 163



# Accessories for experimental flumes HM 160, HM 161, HM 162 and HM 163

Over the following pages we will present the complete range of accessories available for the GUNT experimental flumes, using HM 162 as an example. The accessories for the other experimental flumes are similar.

## Control structures

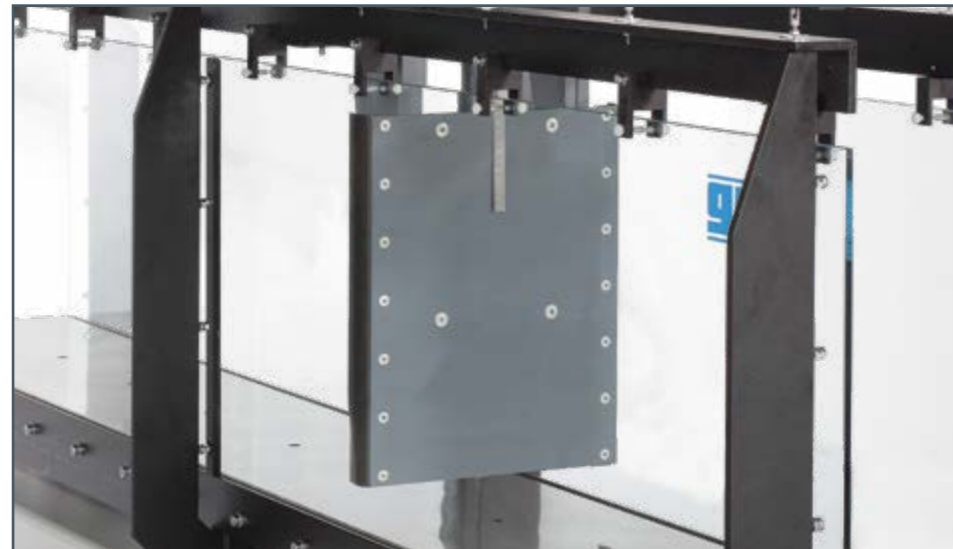

Sluice gate
HM 160.29 Sluice gate
HM 161.29 Sluice gate
HM 162.29 Sluice gate
HM 163.29 Sluice gate



Broad-crested weir
HM 160.31 Broad-crested weir
HM 161.31 Broad-crested weir
HM 162.31 Broad-crested weir
HM 163.31 Broad-crested weir



Radial gate
HM 160.40 Radial gate
HM 161.40 Radial gate
HM 162.40 Radial gate
HM 163.40 Radial gate

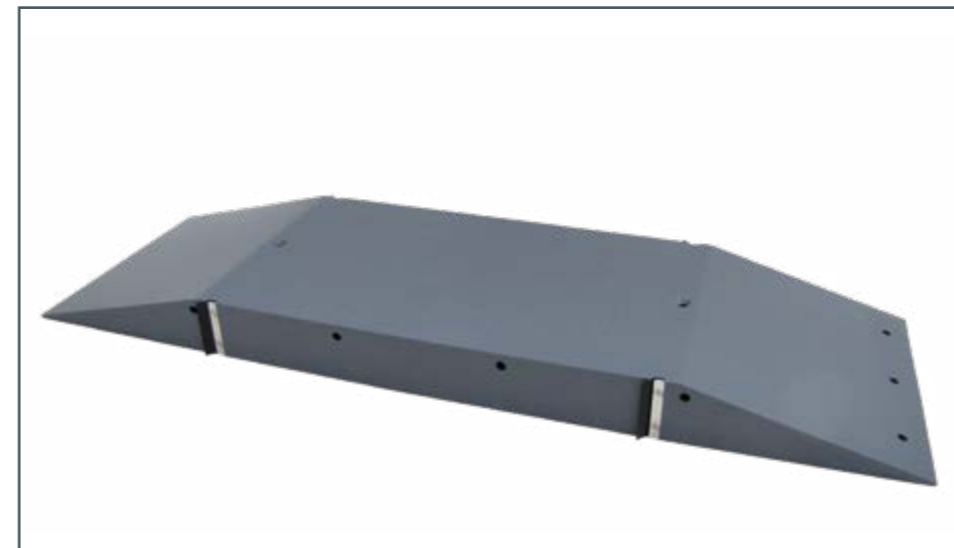

Sill
HM 160.44 Sill
HM 161.44 Sill
HM 162.44 Sill
HM 163.44 Sill



Sharp-crested weirs / plate weirs
Rehbock, Cipoletti, Thomson; rectangular weir without contraction
HM 160.30 Set of plate weirs, four types
HM 161.30 Set of plate weirs, four types
HM 162.30 Set of plate weirs, four types
HM 163.30 Set of plate weirs, four types



Crump weir
HM 160.33 Crump weir
HM 161.33 Crump weir
HM 162.33 Crump weir
HM 163.33 Crump weir

# Accessories for experimental flumes HM 160, HM 161, HM 162 and HM 163



## Control structures



**Ogee-crested weir**

- HM 160.32 Ogee-crested weir with two weir outlets
- HM 161.32 Ogee-crested weir with two weir outlets
- HM 162.32 Ogee-crested weir with two weir outlets
- HM 163.32 Ogee-crested weir with two weir outlets



Optional expansion for the ogee-crested weir:  
**Energy dissipation elements**  
including chute block and sills

- HM 160.35 Elements for energy dissipation
- HM 161.35 Elements for energy dissipation
- HM 162.35 Elements for energy dissipation
- HM 163.35 Elements for energy dissipation



**Ogee-crested weir with pressure measuring points along the weir downstream side**

- HM 160.34 Ogee-crested weir with pressure measurement
- HM 161.34 Ogee-crested weir with pressure measurement
- HM 162.34 Ogee-crested weir with pressure measurement
- HM 163.34 Ogee-crested weir with pressure measurement

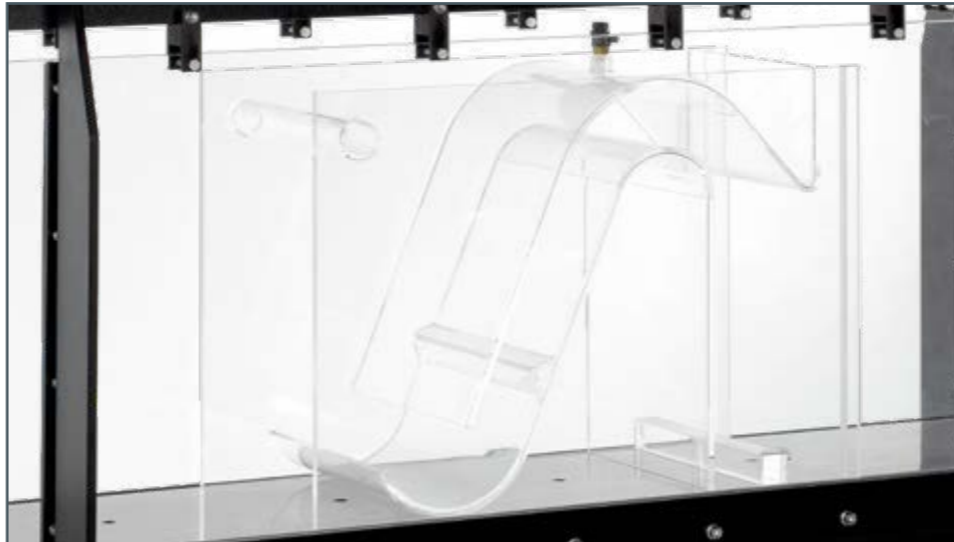

**Siphon weir**

- HM 160.36 Siphon weir
- HM 161.36 Siphon weir
- HM 162.36 Siphon weir
- HM 163.36 Siphon weir



**Rake**

- HM 161.38 Rake
- HM 162.38 Rake
- HM 163.38 Rake



# Accessories for experimental flumes HM 160, HM 161, HM 162 and HM 163



## Discharge measurement

	<b>Sharp-crested weirs / plate weirs</b> Rehbock, Cipoletti, Thomson; rectangular weir without contraction
	<b>HM 160.30</b> Set of plate weirs, four types
	<b>HM 161.30</b> Set of plate weirs, four types
	<b>HM 162.30</b> Set of plate weirs, four types
<b>HM 163.30</b> Set of plate weirs, four types	

	<b>Venturi flume</b>
	<b>HM 160.51</b> Venturi flume
	<b>HM 161.51</b> Venturi flume
	<b>HM 162.51</b> Venturi flume
<b>HM 163.51</b> Venturi flume	

	<b>Parshall flume</b>
	<b>HM 161.55</b> Parshall flume
	<b>HM 162.55</b> Parshall flume
	<b>HM 163.55</b> Parshall flume

## Discharge measurement

	<b>Trapezoidal flume</b>
	<b>HM 161.63</b> Trapezoidal flume
	<b>HM 162.63</b> Trapezoidal flume
	<b>HM 163.63</b> Trapezoidal flume

## Change in cross-section

	<b>Sill</b>
	<b>HM 160.44</b> Sill
	<b>HM 161.44</b> Sill
	<b>HM 162.44</b> Sill
<b>HM 163.44</b> Sill	

	<b>Flume bottom with pebble stones</b>
	<b>HM 160.77</b> Flume bottom with pebble stones
	<b>HM 161.77</b> Flume bottom with pebble stones
	<b>HM 162.77</b> Flume bottom with pebble stones
	<b>HM 163.77</b> Flume bottom with pebble stones

# Accessories for experimental flumes HM 160, HM 161, HM 162 and HM 163



## Change in cross-section



### Crump weir

HM 160.33  
Crump weir

HM 161.33  
Crump weir

HM 162.33  
Crump weir

HM 163.33  
Crump weir

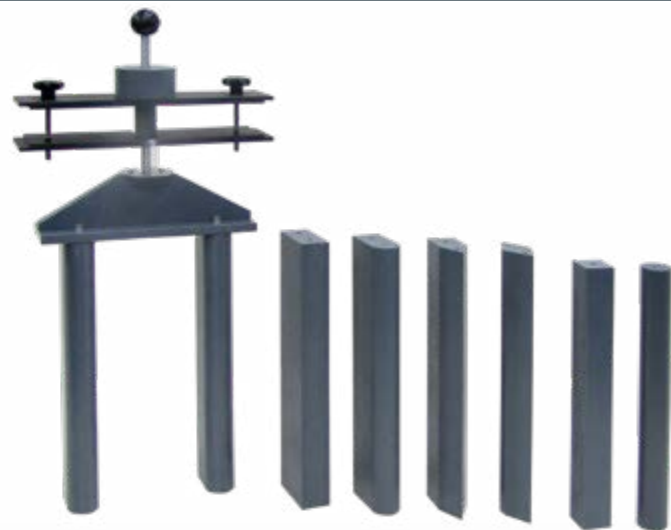

### Piers

7 profiles: rectangular, square, circular, rounded (one end or both ends), pointed-nosed (one end or both ends)

HM 160.46  
Set of piers, seven profiles

HM 161.46  
Set of piers, seven profiles

HM 162.46  
Set of piers, seven profiles

HM 163.46  
Set of piers, seven profiles



### Culvert

HM 160.45  
Culvert

HM 161.45  
Culvert

HM 162.45  
Culvert

HM 163.45  
Culvert

## Wave generator

The wave generator HM 16x.41 is available as an accessory for all experimental flumes and generates periodic, harmonic waves with different wavelengths and/or wave heights.

An electric motor drives a crank disk, which is connected to a plate via a driving rod. The plate performs a harmonic stroke movement. The speed of the crank disk, in other words the frequency, with which the plate is moved back and forth can be adjusted, therefore affecting the wavelength of the

generated waves. Furthermore, the stroke is finely adjustable, so that the wave height (amplitude) can be varied.

The speed of the crank disk is set differently:

- at HM 160.41 on the included control unit
- at HM 162.41 / HM 163.41 / HM 161.41 via touch screen at the experimental flume



Wave generator  
HM 162.41

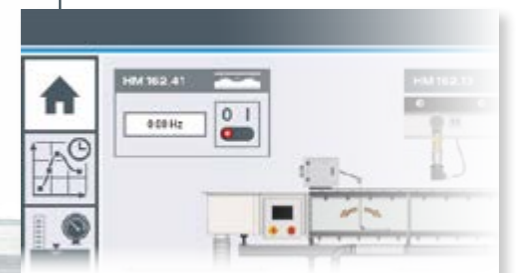

Touch screen

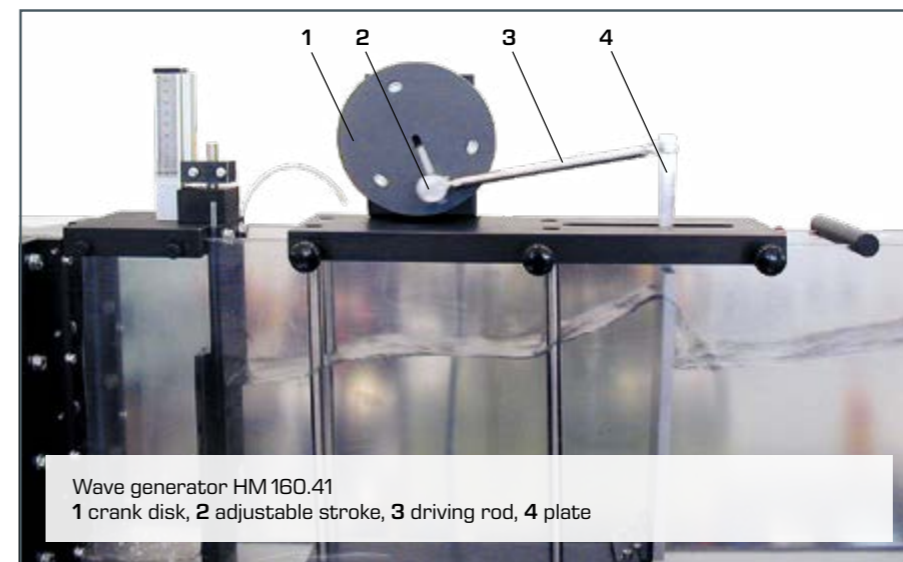

Wave generator HM 160.41  
1 crank disk, 2 adjustable stroke, 3 driving rod, 4 plate

### Wave generator

HM 160.41  
Wave generator

HM 161.41  
Wave generator

HM 162.41  
Wave generator

HM 163.41  
Wave generator



# Accessories for experimental flumes HM 160, HM 161, HM 162 and HM 163



## Beaches



<b>Plain beach</b>
HM 160.42 Plain beach



<b>Set of beaches</b> 3 beaches: plain, rough, permeable
HM 161.80 Set of beaches
HM 162.80 Set of beaches
HM 163.80 Set of beaches

## Flow-induced vibrations



<b>Vibrating piles</b>
HM 160.61 Vibrating piles
HM 161.61 Vibrating piles
HM 162.61 Vibrating piles
HM 163.61 Vibrating piles

## Sediment transport



<b>Sediment trap</b>
HM 160.72 Sediment trap
HM 161.72 Sediment trap
HM 162.72 Sediment trap
HM 163.72 Sediment trap



<b>Sediment feeder</b>
HM 160.73 Sediment feeder
HM 161.73 Sediment feeder
HM 162.73 Sediment feeder
HM 163.73 Sediment feeder

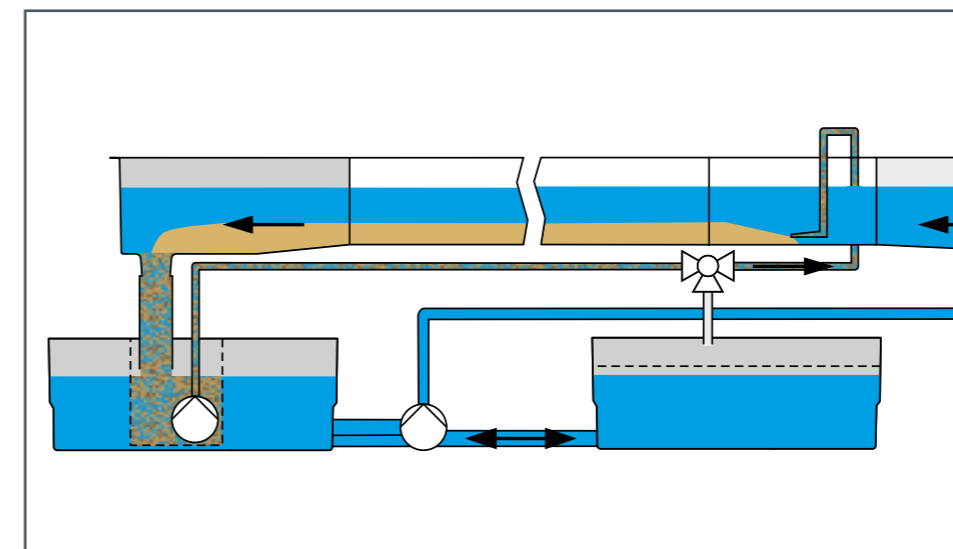

<b>Closed sediment circuit</b>
HM 161.71 Closed sediment circuit
HM 162.71 Closed sediment circuit
HM 163.71 Closed sediment circuit



# Accessories for experimental flumes HM 160, HM 161, HM 162 and HM 163



## Sediment transport

Flows in rivers, canals and coastal areas are often associated with sediment transport. Bed-load transport is the main transport mechanism. During bed-load transport, solids are moved along the flume bottom.

The described accessories for the GUNT experimental flumes consider bed-load transport only. The used sediment is sand with a grain size of 1...2mm. The sediment is introduced at the inlet of the experimental section. At the end of the experimental section, a sediment trap separates the sediment.

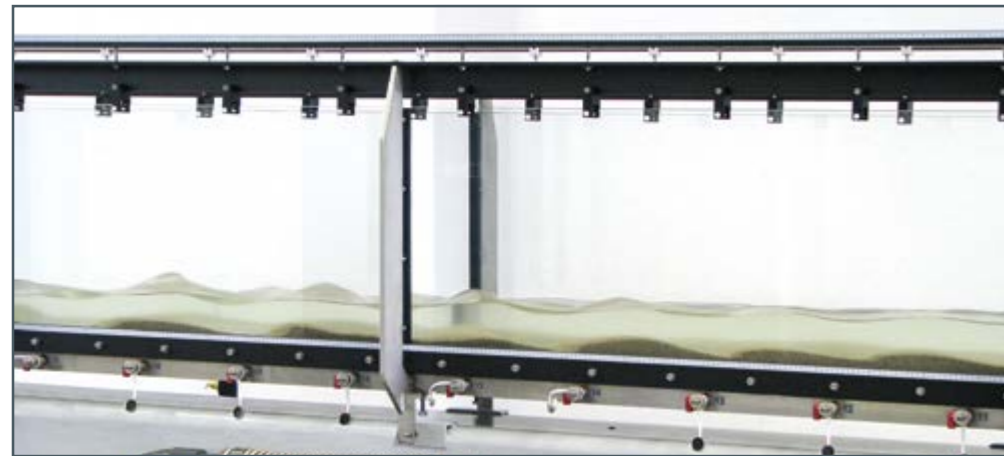

Dune migration

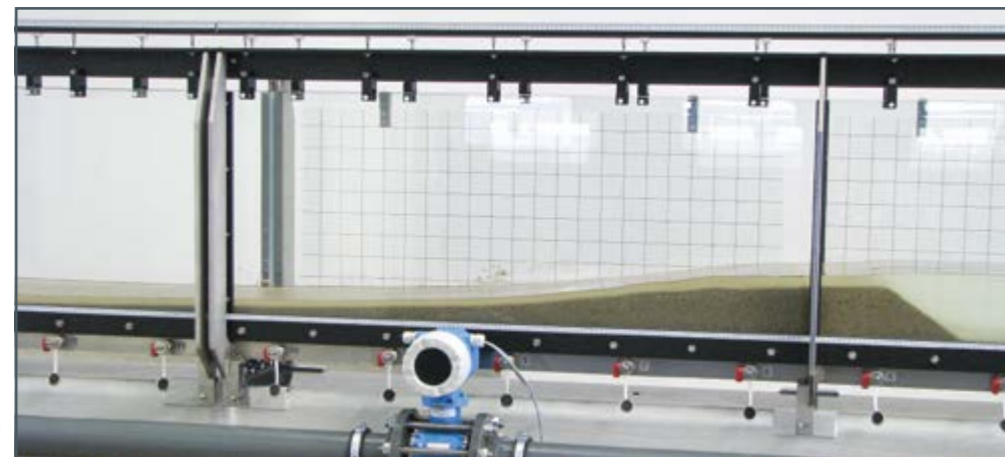

Sediment transport in running waters

## Sediment feed

The sediment is added manually with a shovel or a bucket included in the scope of delivery of the sediment trap HM 16x.72.

Alternatively, the sediment feeder HM 16x.73 can be used. This feeder essentially consists of a vibrating conveyor, via which sediment is introduced into the experimental section. The feeder is mounted above the inlet of the experimental section.

Sediment feeder  
HM 160.73



## Sediment trap

The purpose of the sediment trap is to separate sediment from the flow to prevent sediment from entering the pump or the flow meter. The flow near the bottom of the flume contains the sediment.

The sediment trap HM 160.72 is inserted in the water tank after the outlet element. It consists of a fine mesh screen and serves to collect the sediment.

For the larger experimental flumes HM 162, HM 163 and HM 161, the sediment trap HM 162.72 / HM 163.72 / HM 161.72 is permanently mounted between the experimental section and the outlet element. The flow near the bottom is fed into this sediment trap. In the trap, the sediment sinks to the bottom and accumulates. The sediment-free water continues to flow into the outlet element. The sediment is removed manually from the trap and delivered back to the feed.



Sediment trap HM 160.72 in the water tank of HM 160 for collecting the sediment

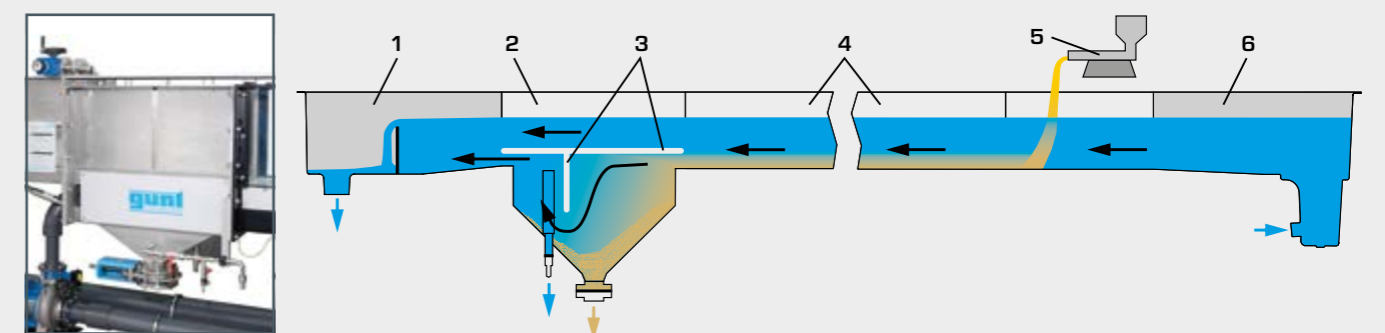

Sediment trap HM 162.72 / HM 163.72 / HM 161.72

1 outlet element, 2 sediment trap, 3 separator, 4 experimental section with sediment, 5 sediment feed (either manually with a bucket or with sediment feeder HM 16x.73), 6 inlet element; sediment, water

For HM 162 / HM 163 / HM 161, the closed sediment circuit HM 16x.71 is available as an alternative to the sediment trap. The accessory is automatically identified by the PLC and dis-

played on the touch screen of the experimental flume. The sediment pump is operated via touchscreen of HM 162 / HM 163 / HM 161.

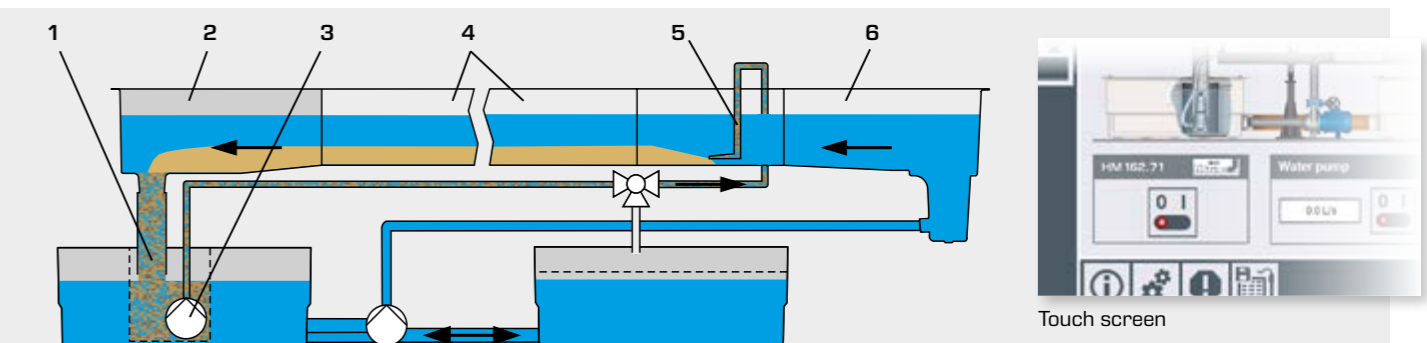

Closed sediment circuit HM 162.71 / HM 163.71

1 screen basket, 2 outlet element, 3 pump, 4 experimental section with sediment, 5 sediment feeder, 6 inlet element; sediment, water

Touch screen



# Accessories for experimental flumes HM 160, HM 161, HM 162 and HM 163



## Measuring instruments



**Level gauge**  
analogue or with digital display

HM 160.52 Level gauge  
HM 160.91 Digital level gauge

HM 161.52 Level gauge  
HM 161.91 Digital level gauge

HM 162.52 Level gauge  
HM 162.91 Digital level gauge

HM 163.52 Level gauge  
HM 163.91 Digital level gauge



**Velocity measurement**  
via pitotstatic tube

HM 160.50  
Pitotstatic tube

HM 161.50  
Pitotstatic tube

HM 162.50  
Pitotstatic tube

HM 163.50  
Pitotstatic tube



**Velocity measurement**  
via velocity meter

HM 160.64  
Velocity meter

HM 161.64  
Velocity meter

HM 162.64  
Velocity meter

HM 163.64  
Velocity meter

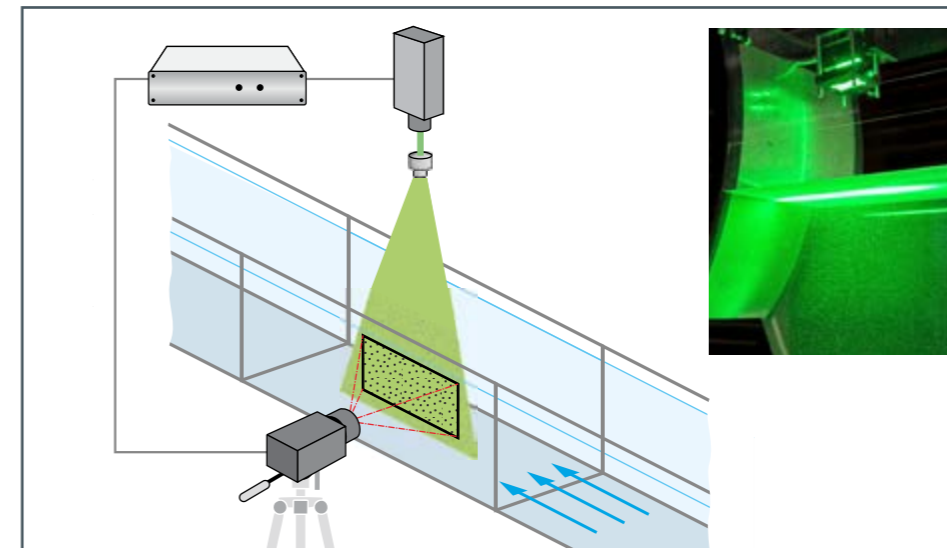

**PIV-System**

HM 161.81 PIV-System  
HM 161.82 Instrument carrier  
HM 161.83 Glass cut-out

HM 162.81 PIV-System  
HM 162.82 Instrument carrier  
HM 162.83 Glass cut-out

HM 163.81 PIV-System  
HM 163.82 Instrument carrier  
HM 163.83 Glass cut-out



**Instrument carrier**  
accessory required for the level gauge  
and the velocity measurement

HM 161.59  
Instrument carrier

HM 162.59  
Instrument carrier

HM 163.59  
Instrument carrier

# Accessories for experimental flumes HM 160, HM 161, HM 162 and HM 163



## Measuring instruments



### Pressure measurement

HM 160.53  
Ten tube manometers

HM 161.53  
20 tube manometers

HM 162.53  
Ten tube manometers

HM 163.53  
Ten tube manometers

## Other accessories

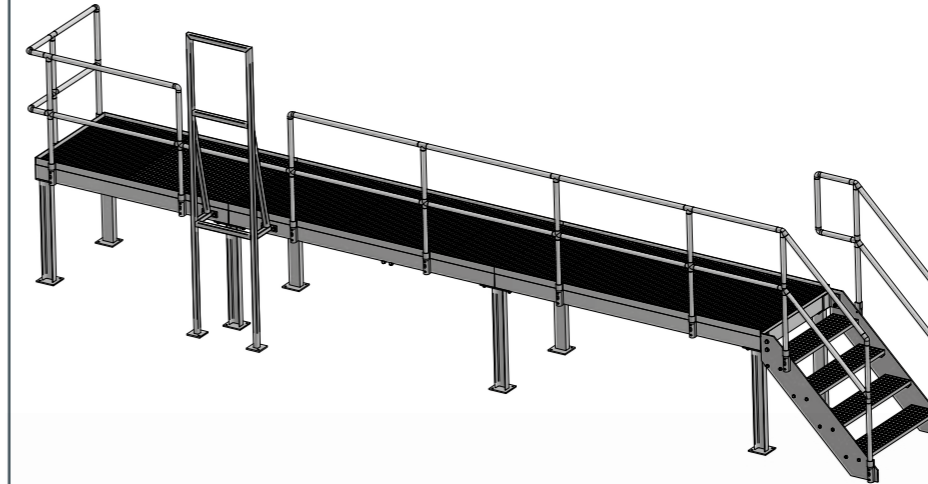

### Gallery

HM 162.14  
Gallery

HM 163.14  
Gallery

### Gallery extension element, 2,5m

HM 162.15  
Extension element of the gallery

HM 163.15  
Extension element of the gallery



### Electronic pressure measurement

HM 161.13 Electronic pressure measurement, 10x 0...100mbar

HM 162.13 Electronic pressure measurement, 10x 0...50mbar also suitable for HM 163



### Experimental flume extension element, 2,5m for longer experimental sections

HM 160.10 Extension element of the experimental flume

HM 162.10 Extension element of the experimental flume

HM 163.10 Extension element of the experimental flume

## Electrical inclination adjustment

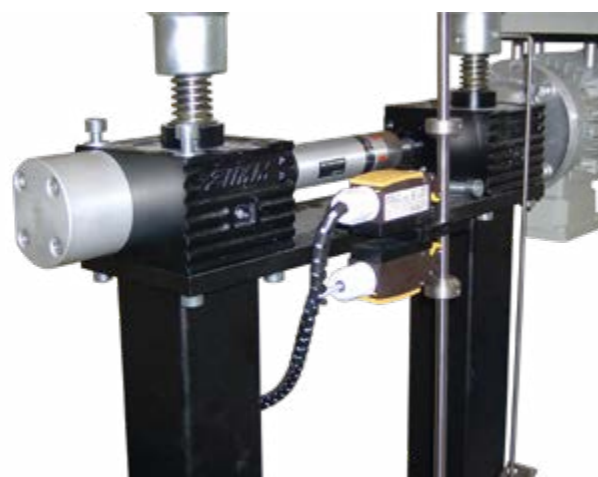

recommended for experimental sections larger than 7,5m

HM 162.57  
Electrical inclination adjustment also suitable for HM 163



### Water tank, 1100L

HM 162.20  
Water tank

HM 163.20  
Water tank



# Open-channel flow in the lab



HM 162.29 Sluice gate



HM 162.40 Radial gate



HM 162.36 Siphon weir



HM 162.32 Ogee-crested weir with two weir outlets

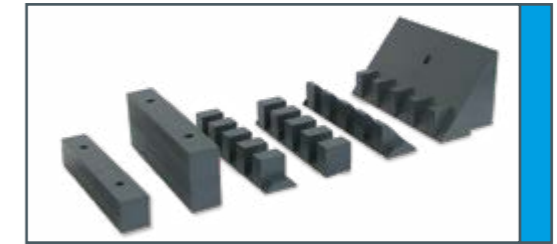

HM 162.35 Elements for energy dissipation



HM 162.38 Rake

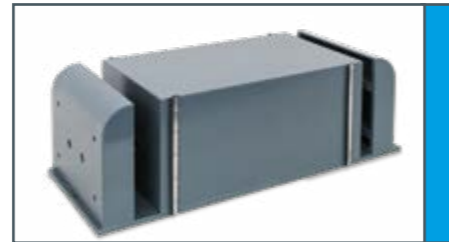

HM 162.31 Broad-crested weir

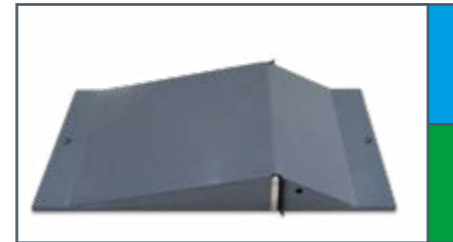

HM 162.33 Crump weir



HM 162.34 Ogee-crested weir with pressure measurement

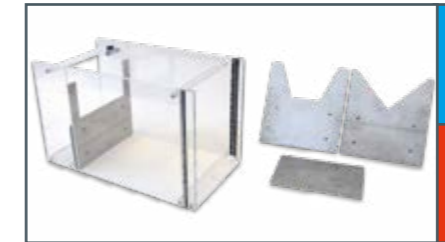

HM 162.30 Set of plate weirs, four types



HM 162.63 Trapezoidal flume



HM 162.44 Sill

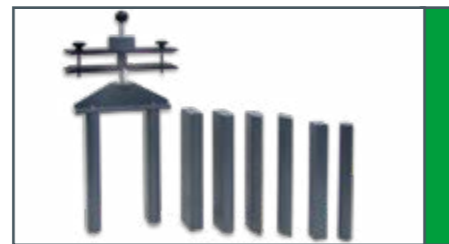

HM 162.46 Set of piers, seven profiles



HM 162 with an experimental section of 7,5m

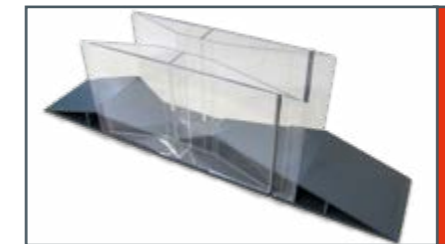

HM 162.55 Parshall flume



HM 162.51 Venturi flume

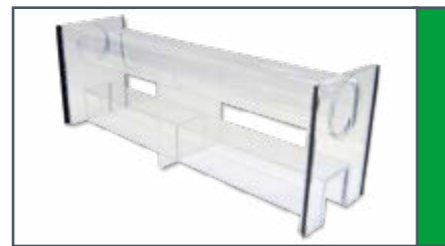

HM 162.45 Culvert

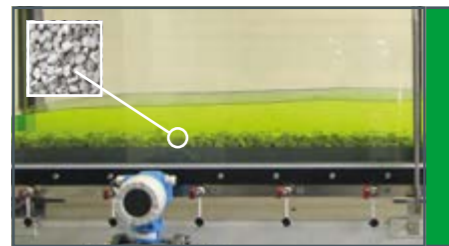

HM 162.77 Flume bottom with pebble stones

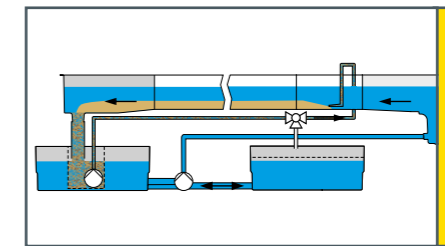

HM 162.71 Closed sediment circuit



HM 162.61 Vibrating piles



HM 162.80 Set of beaches



HM 162.41 Wave generator



HM 162.72 Sediment trap



HM 162.73 Sediment feeder

- Control structures
- Changes in cross-section (losses, flow formulae)
- Discharge measurement
- Other experiments: including waves, sediment transport

The appropriate instrumentation for measuring the discharge depth and the flow velocity is also available as additional accessories.

A wide range of typical models allows the user to design a broad and individual programme of experiments with GUNT experimental flumes. The programme of experiments shown in this catalogue for HM 162 applies, in principle, for all GUNT experimental flumes.

The models of the other GUNT experimental flumes are similar.



# GUNT experimental flumes Instrumentation

## Instrument carrier for HM 162, HM 163 and HM 161

The experimental flumes HM 162, HM 163 and HM 161 extend above the side wall guide rails. An instrument carrier can be placed on the rails and moved. The different instruments are mounted on the instrument carrier, for example a level gauge or a pitotstatic tube. Using the carrier, the instruments can be moved to nearly every point of the flow. The carrier can be locked during the measurements with fixing devices. The position of the carrier along the experimental section is read on a scale (see photo). On the carrier itself is another scale, used to determine the position transverse to the direction of flow.

In the small experimental flume HM 160 no instrument carrier is necessary. The instruments are placed directly on the top of the experimental section and clamped in place.



Scale along the experimental section

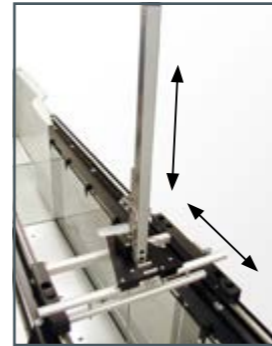

Instrument carrier with level gauge

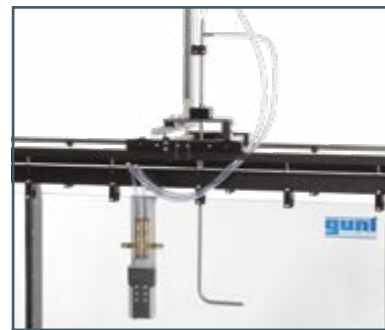

Pitotstatic tube HM 162.50 with instrument carrier

### Flow velocity

GUNT offers two methods of measuring the flow rate in all experimental flumes: the traditional pitotstatic tube or a digital velocity meter. The pitotstatic tube HM 16x.50 measures the static pressure and the total pressure at any point of the flow. A digital pressure gauge displays the difference between the two pressures. The pressure difference corresponds to the dynamic pressure, from which the flow velocity can be calculated.

The core element of the velocity meter HM 16x.64 is an impeller that is rotated by the flow. The speed of the impeller is proportional to the flow velocity. The flow velocity is read directly from the digital display.



Velocity meter HM 16x.64

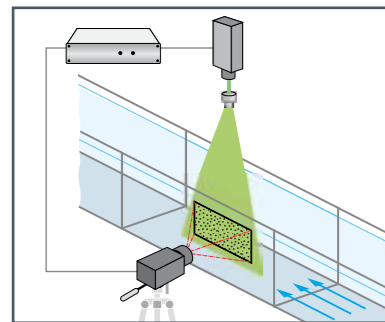

PIV-System HM 162.81

### PIV-System

A PIV system (Particle Image Velocimetry) is used to record velocity fields in the experimental flume. HM 16x.81 includes a complete system with light sectioning optics, camera and synchronizer. This system is suitable for two-dimensional flow measurements.

For experiments where the light source is to be mounted above the flume, the HM 16x.82 instrument carrier can be used as an option. If the light source is to be positioned under the flume, a HM 16x.83 glass cut-out is available for the base of the flume.

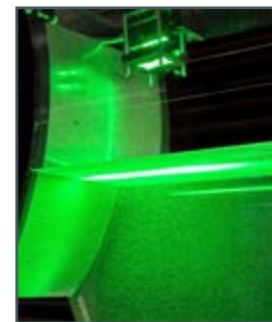

Level gauge HM 162.52 with instrument carrier

### Discharge depth

To measure the discharge depth, the level gauge HM 16x.52 or HM 16x.91 with digital display is used. The tip of the probe is moved to the surface of the water from above.



Digital level gauge HM 162.91 with instrument carrier

## Measuring methods in your laboratory

Of course, you can also use your own laboratory measuring methods to determine the flow velocity, such as PIV (Particle

Image Velocimetry) or LDA (Laser Doppler Anemometry) and ultrasound to determine the discharge depth.

## Pressure measurement along the experimental section

All experimental flumes are equipped with pressure measuring points in the flume bottom, distributed over the length of the experimental section. To read these pressures, the pressure measuring points are connected to the optional manometer panel HM 16x.53 via hoses.

The elements of the experimental section of HM 160 contain ten pressure measuring points over a length of 2,5m. The manometer panel HM 160.53 contains ten tubes.

The elements of the experimental section of HM 162/HM 163 each contain ten pressure measuring points, which are uniformly distributed over the length of the 2,5m element.

In HM 161, 48 pressure measuring points are evenly distributed over the experimental section with 16m length. The manometer panel HM 161.53 contains 20 tubes.

## Example

A broad-crested weir (HM 162.31) and a sluice gate (HM 162.29) have been inserted in the 5m long experimental section of HM 162.

The pressure at these measuring points is called the pressure head and corresponds to the discharge depth. The pressure heads are displayed on the manometer panel HM 162.53.

When the experimental section is inclined, i.e. open-channel flow with a slope, it is more accurate to measure the discharge depth via the pressure head than via a level gauge.

The manometer panel HM 162.53 contains ten tubes. Depending on the length of the experimental section, we can either represent selected points on a panel or use multiple panels to show all pressures.



Tube manometers HM 162.53

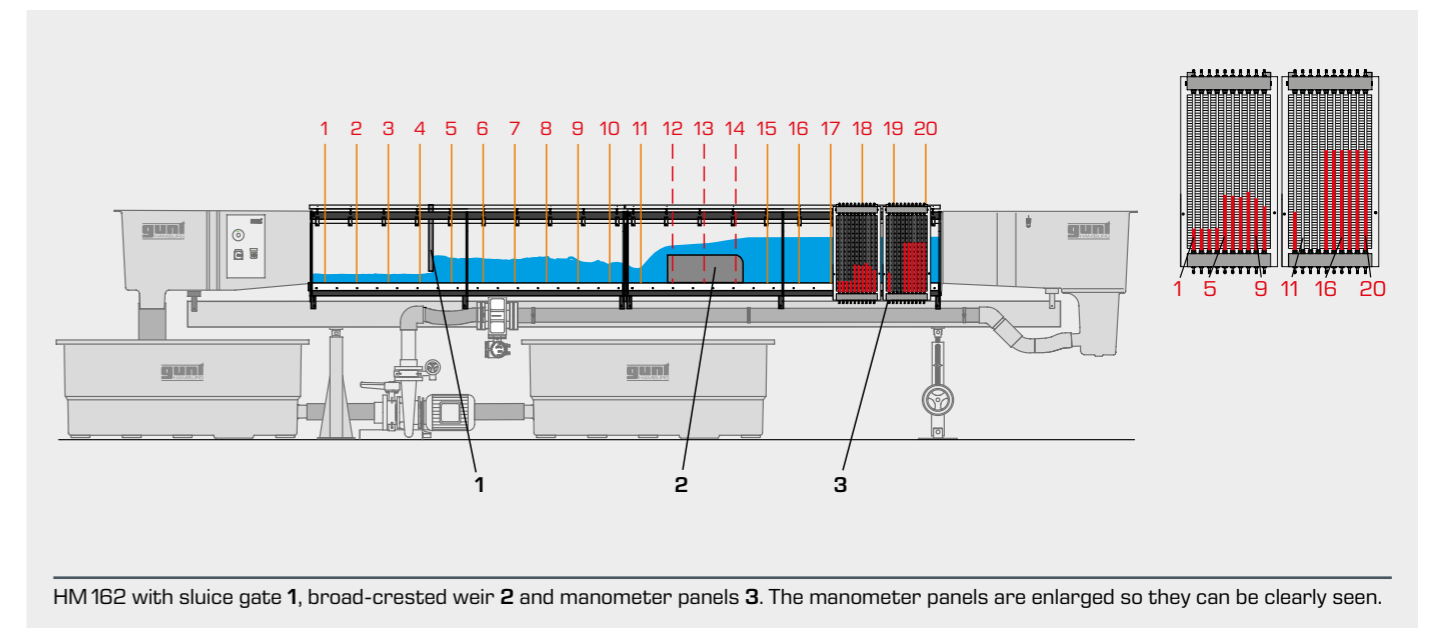

HM 162 with sluice gate 1, broad-crested weir 2 and manometer panels 3. The manometer panels are enlarged so they can be clearly seen.



## The complete GUNT programme



### Engineering mechanics and engineering design

- statics
- strength of materials
- dynamics
- machine dynamics
- engineering design
- materials testing

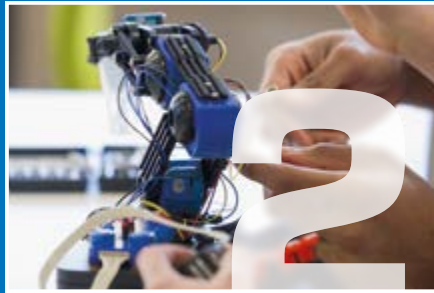

### Mechatronics

- engineering drawing
- cutaway models
- dimensional metrology
- fasteners and machine parts
- manufacturing engineering
- assembly projects
- maintenance
- machinery diagnosis
- automation and process control engineering



### Thermal engineering

- fundamentals of thermodynamics
- heat exchangers
- thermal fluid energy machines
- internal combustion engines
- refrigeration
- HVAC



### Fluid mechanics

- steady flow
- transient flow
- flow around bodies
- components in piping systems and plant design
- turbomachines
- positive displacement machines
- hydraulic engineering



### Process engineering

- mechanical process engineering
- thermal process engineering
- chemical process engineering
- biological process engineering
- water treatment



### 2E Energy & Environment

- | Energy                           | Environment |
|----------------------------------|-------------|
| ■ solar energy                   | ■ water     |
| ■ hydropower and ocean energy    | ■ air       |
| ■ wind power                     | ■ soil      |
| ■ biomass                        | ■ waste     |
| ■ geothermal energy              |             |
| ■ energy systems                 |             |
| ■ energy efficiency in buildings |             |

## Contact

G.U.N.T. Gerätebau GmbH  
Hanskampring 15-17  
22885 Barsbuettel  
Germany

+49 40670854-0  
sales@gunt.de  
www.gunt.de



Visit our website  
[www.gunt.de](http://www.gunt.de)